



GROWELL TRADING SAS



DENTAL INSTRUMENTS CATALOGUE

www.gwelltrade.com



| | | |
|-------------|--|-----------|
| | | 01 |
| Page 01-05 | Dental Scissors | |
| | | 02 |
| Page 06-14 | Dental Dressing Forceps Dressing Forceps Tweezers Dressing Forceps Scissors Needle Holder | |
| | | 03 |
| Page 15-33 | Tooth Extraction Forceps | |
| | | 04 |
| Page 34-73 | Mouth Mirrors, Dental Probe, Dental Excavator Periodontal Curette, Tissue Forceps Alligators Tissue Forceps Scissors, Dental Dressing Forceps Dental Scaler, Dental Amalgam Carrier Dental Wax Carver, Dental Spatula | |
| | | 05 |
| Page 74-83 | Dental Elevators | |
| | | 06 |
| Page 84-110 | Mouth Gags, Hand-Held Retractor, Tissue Forceps Scissors Chisels, Bone File/Rasp, Dental Elevator, Dental Osteotome Periodontal Curette, Bone Curette, Orthodontic Gauge, Mallet Periosteal Elevator, Self-Retaining Retractor, Surgical Probe Dental Dressing Forceps, Hooks, Suction Tubes | |



07

Dental Aspiration Syringe Page 111 - 115

08

Rubber Dam Clamp Forceps, Rubber Dam Clamp,
Dental Matrix Retainer, Dental Scaler, Orthodontic Gauge
Dental Crown Removers, Dental Dressing Forceps
Dental Scissors, Dressing Forceps Tweezers
Bone Saw, Mallet Page 116 - 129

09

Dental Articulators Page 130 - 131

10

Orthodontic Pliers, Bone Cutter, Dental Rongeurs Page 132 - 149

11

Dental Impression Tray, Dental Wax Carver Page 150 - 154

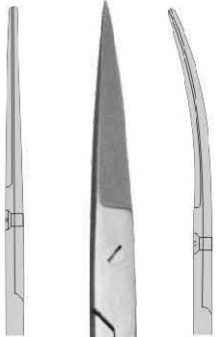
12

Sterilization Container, Instrument Tray
Tissue Forceps Scissors, Dental Dressing Forceps Page 155 - 164



Page 01-05

- DENTAL SCISSORS



TM-01-100
11.5 cm
TM-01-102
14.5 cm
Straight



TM-01-101
11.5 cm
TM-01-103
14.5 cm
Curved



TM-01-104
11.5 cm
TM-01-106
14.5 cm
Straight



TM-01-105
11.5 cm
TM-01-107
14.5 cm
Curved



TM-01-108
11.5 cm
TM-01-110
14.5 cm
Straight



TM-01-109
11.5 cm
TM-01-111
14.5 cm
Curved



TM-01-112
Straight



TM-01-113
Curved



Operating Standard
Sharp / Sharp



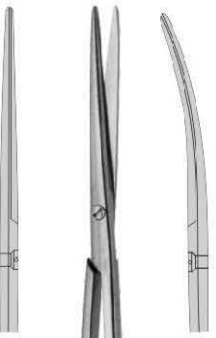
Operating Standard
Blunt / Sharp



Operating Standard
Blunt / Blunt



Mayo
14.5 cm



TM-01-114
Straight



TM-01-115
Curved



TM-01-116
Straight



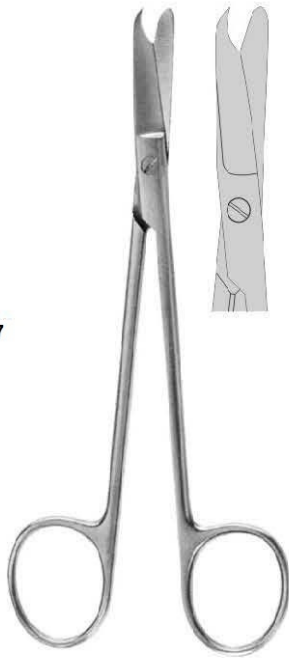
TM-01-117
Curved



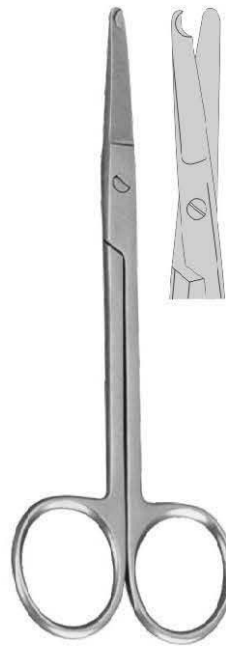
Metzenbaum-Delicate
14.5 cm



Metzenbaum
14.5 cm



TM-01-118
Littauer Suture
14 cm



Spencer Suture
TM-01-119 9 cm
TM-01-120 13cm



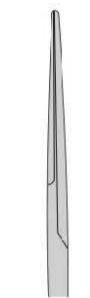
Bandage Lister
TM-01-121 9 cm
TM-01-122 11 cm
TM-01-123 14 cm
TM-01-124 18 cm



Dental Scissors



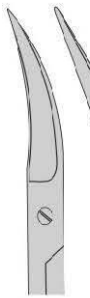
Iris
11.5 cm



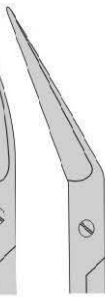
TM-02-126
Straight



TM-02-127
Curved



TM-02-128
Angled



TM-02-129
Angular



Noyes / Castroviejo
12 cm



TM-02-130
Straight



TM-02-131
Curved



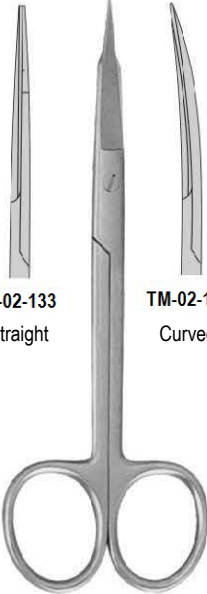
TM-02-132
Angular



TM-02-133
Straight



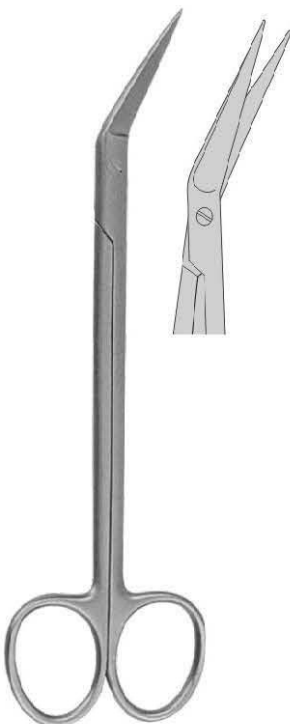
TM-02-134
Curved



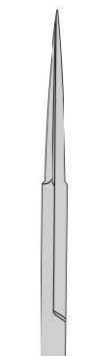
Goldman-Fox
13 cm



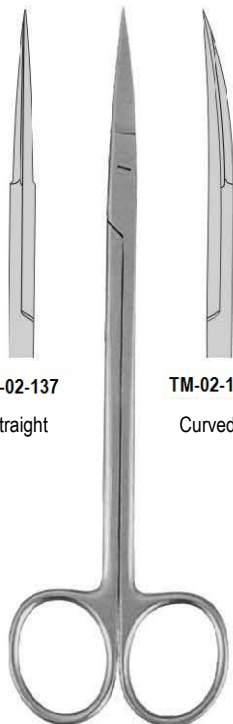
TM-02-135
Universal
18 cm



TM-02-136
Kelly Angular
16 cm



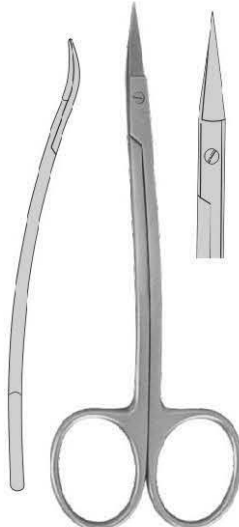
TM-02-137
Straight



TM-02-138
Curved



TM-02-139
Goldman-Fox
13 cm



TM-02-140
La Grange
11.5 cm



TM-03-142
Straight

TM-03-143
Curved

TM-03-144
Angled

TM-03-145
Angular

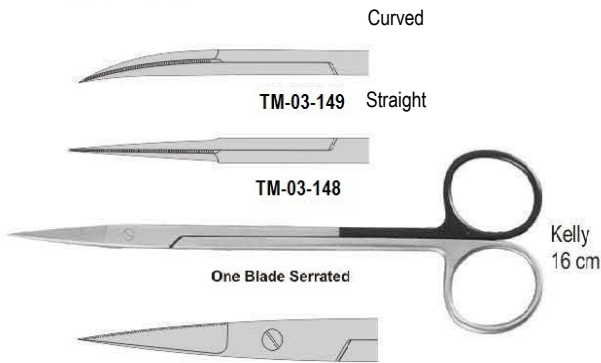
Iris
11.5 cm
One Blade Serrated



TM-03-146

Goldman-Fox
13 cm
One Blade Serrated

TM-03-147
Goldman-Fox
13 cm
One Blade Serrated



TM-03-149
Curved
Straight

TM-03-148

Kelly
16 cm

One Blade Serrated



TM-03-150
Locklin
16 cm
One Blade Serrated

TM-03-151
Locklin
16 cm
One Blade Serrated



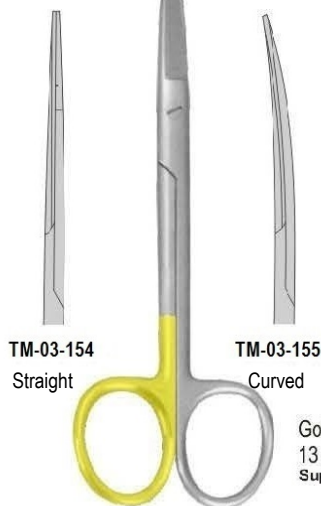
Straight

TM-03-152

Curved

TM-03-153

Iris
11.5 cm
Super-Cut



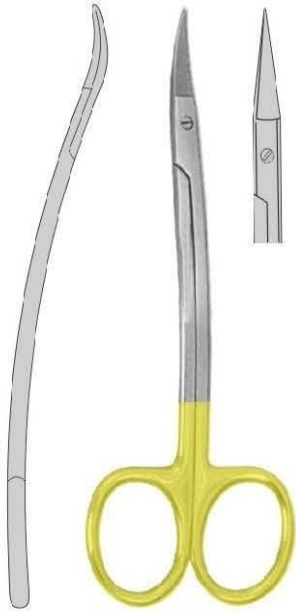
TM-03-154
Straight

TM-03-155
Curved

Goldman-Fox
13 cm
Super-Cut



TM-03-156
La Grange
11.5 cm
Super-Cut



TM-04-159
La Grange
11.5 cm
TC Insert



TM-04-160
Straight

TM-04-161
Curved

Iris
11.5 cm
TC Insert



TM-04-162
Straight

TM-04-163
Curved

Metzenbaum
14.5 cm
TC Insert



TM-04-164
Straight

TM-04-165
Curved

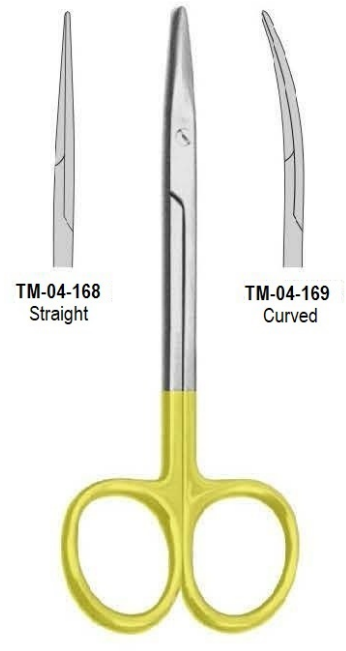
Kelly
16 cm
TC Insert



TM-04-166
Straight

TM-04-167
Curved

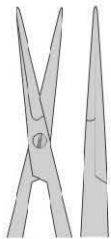
Goldman-Fox
13 cm
TC Insert



TM-04-168
Straight

TM-04-169
Curved

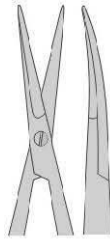
Strabismus
11.5 cm
TC Insert



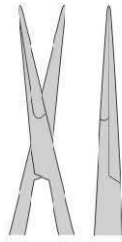
TM-05-170
15 cm
Straight



Micro



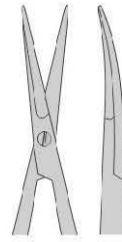
TM-05-171
15 cm
Curved



TM-05-172
18 cm
Straight



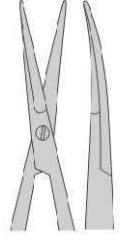
Micro



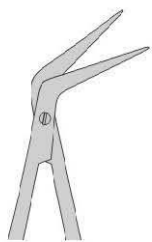
TM-05-173
18 cm
Curved



Micro
one blade serrated



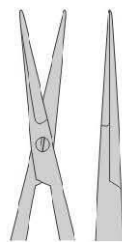
TM-05-174
18 cm
Curved



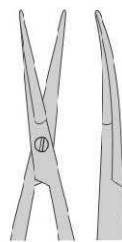
TM-05-180
18 cm
Angular



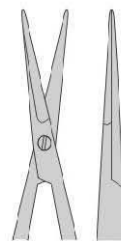
Micro Titanium



TM-05-176
18 cm
Straight



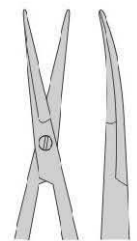
TM-05-177
18 cm
Curved



TM-05-178
15.5 cm
Straight



Micro Titanium



TM-05-179
15.5 cm
Curved



Page

06-14

- DENTAL DRESSING FORCEPS
- DRESSING FORCEPS TWEEZERS
- DRESSING FORCEPS SCISSORS
- TISSUE FORCEPS SCISSORS
- NEEDLE HOLDER



TM-06-181
College
15 cm

TM-06-182
College
15 cm

TM-06-183
College-Locking
15 cm

TM-06-184
Flagg
16 cm

TM-06-185
Meriam
16 cm

TM-06-186
College
15 cm

TM-06-187
Flagg
16 cm

TM-06-188
Meriam
16 cm



TM-06-189
Perry
13 cm

TM-06-190
Perry
13 cm



TM-06-191



TM-06-192
Angled



TM-06-193



TM-06-194
Angled



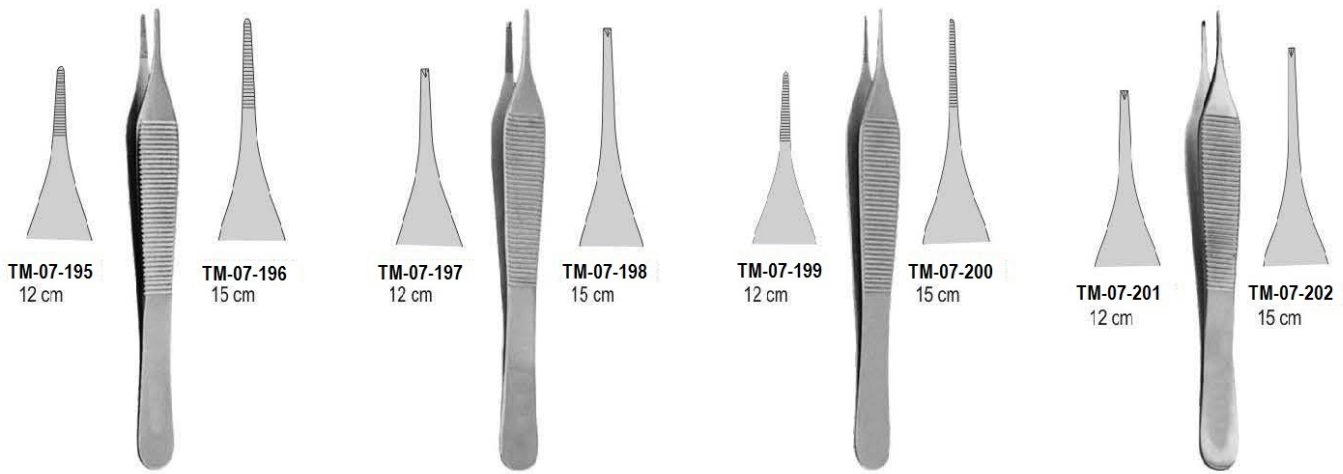
Gerald
18 cm



Gerald
18 cm

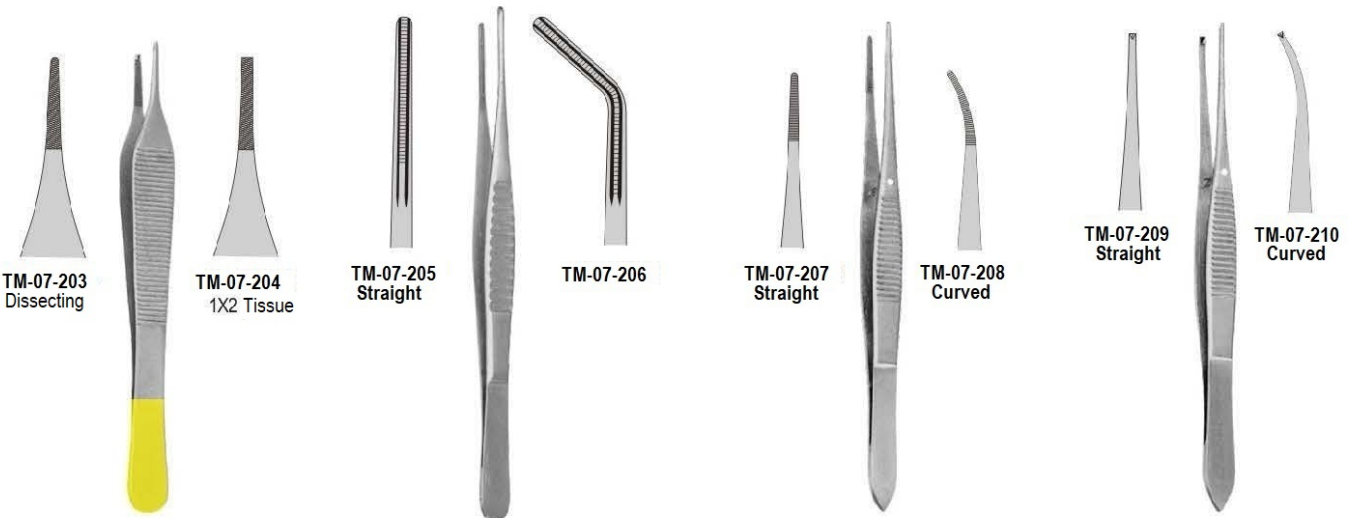


Dressing Forceps Tweezers



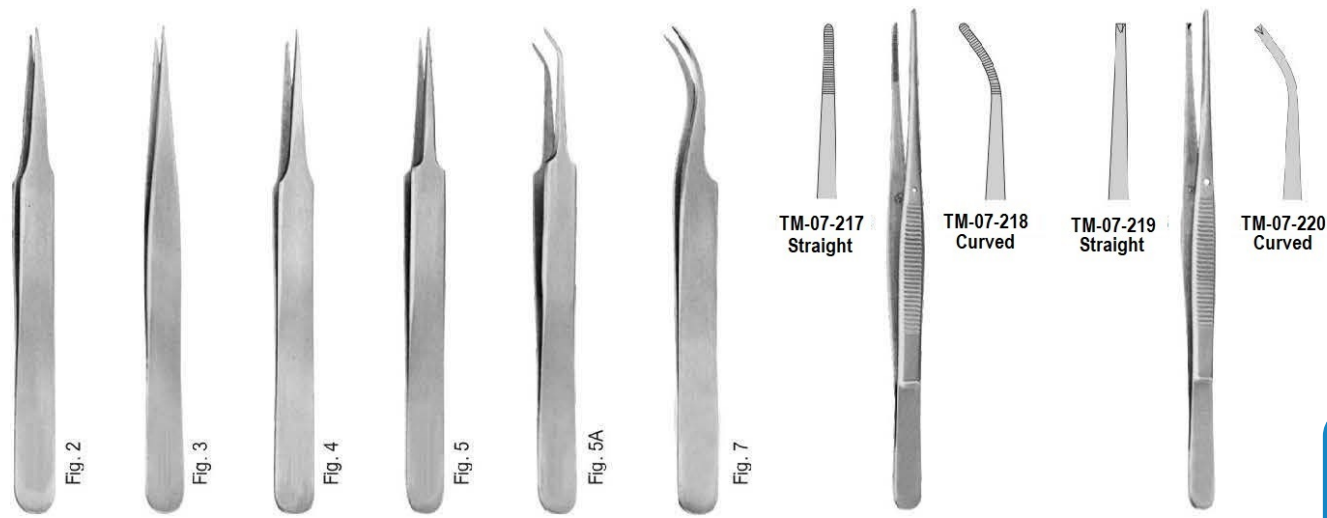
TM-07-195 12 cm TM-07-196 15 cm TM-07-197 12 cm TM-07-198 15 cm TM-07-199 12 cm TM-07-200 15 cm TM-07-201 12 cm TM-07-202 15 cm

Adson Dissecting Adson Tissue 1X2 Micro Adson Dissecting Micro Adson Tissue 1X2



TM-07-203 Dissecting TM-07-204 1X2 Tissue TM-07-205 Straight TM-07-206 TM-07-207 Straight TM-07-208 Curved TM-07-209 Straight TM-07-210 Curved

Adson with Tungsten Carbide 12 cm DeBakey Atraumatic Dissecting 16 cm Iris Dissecting 10 cm Iris 10 cm Tissue

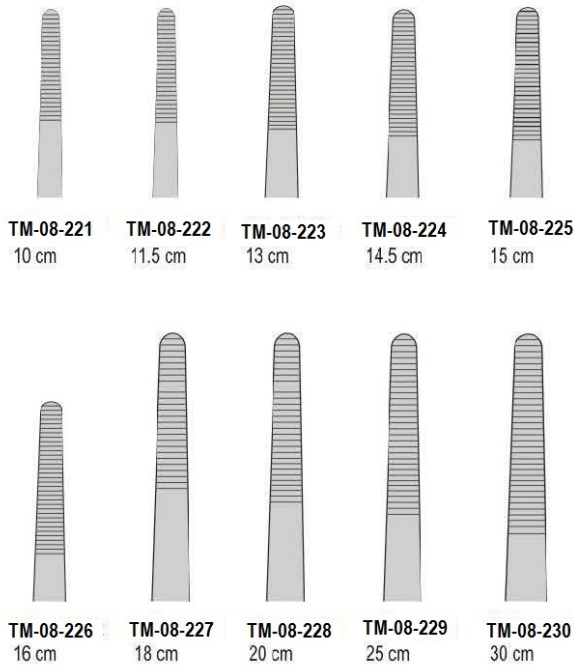


TM-07-211 11 cm TM-07-212 11 cm TM-07-213 11 cm TM-07-214 11 cm TM-07-215 11 cm TM-07-216 11 cm TM-07-217 Straight TM-07-218 Curved TM-07-219 Straight TM-07-220 Curved

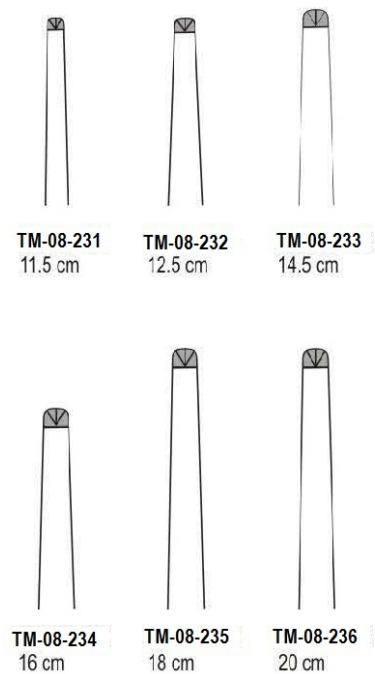
Micro Dissecting Semken Dissecting 12.5 cm Semken 12.5 cm Tissue



Standard Dissecting



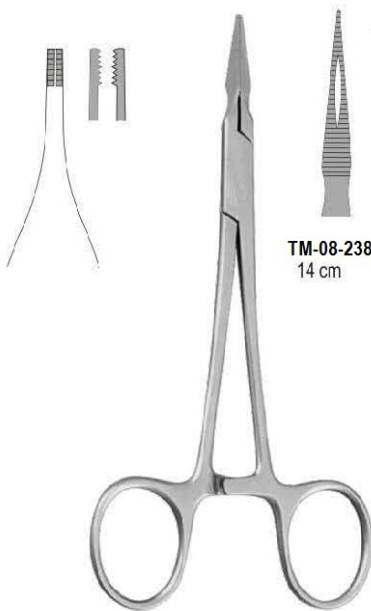
Standard Tissue
1x2



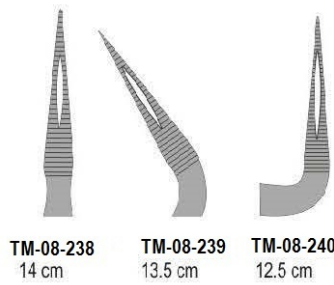
Tissue Forceps Scissors



Adson-Brown Tissue
TM-08-237
12 cm



Stieglitz Splinter



Backhaus Towel
TM-08-241 9 cm
TM-08-242 11 cm
TM-08-243 13 cm



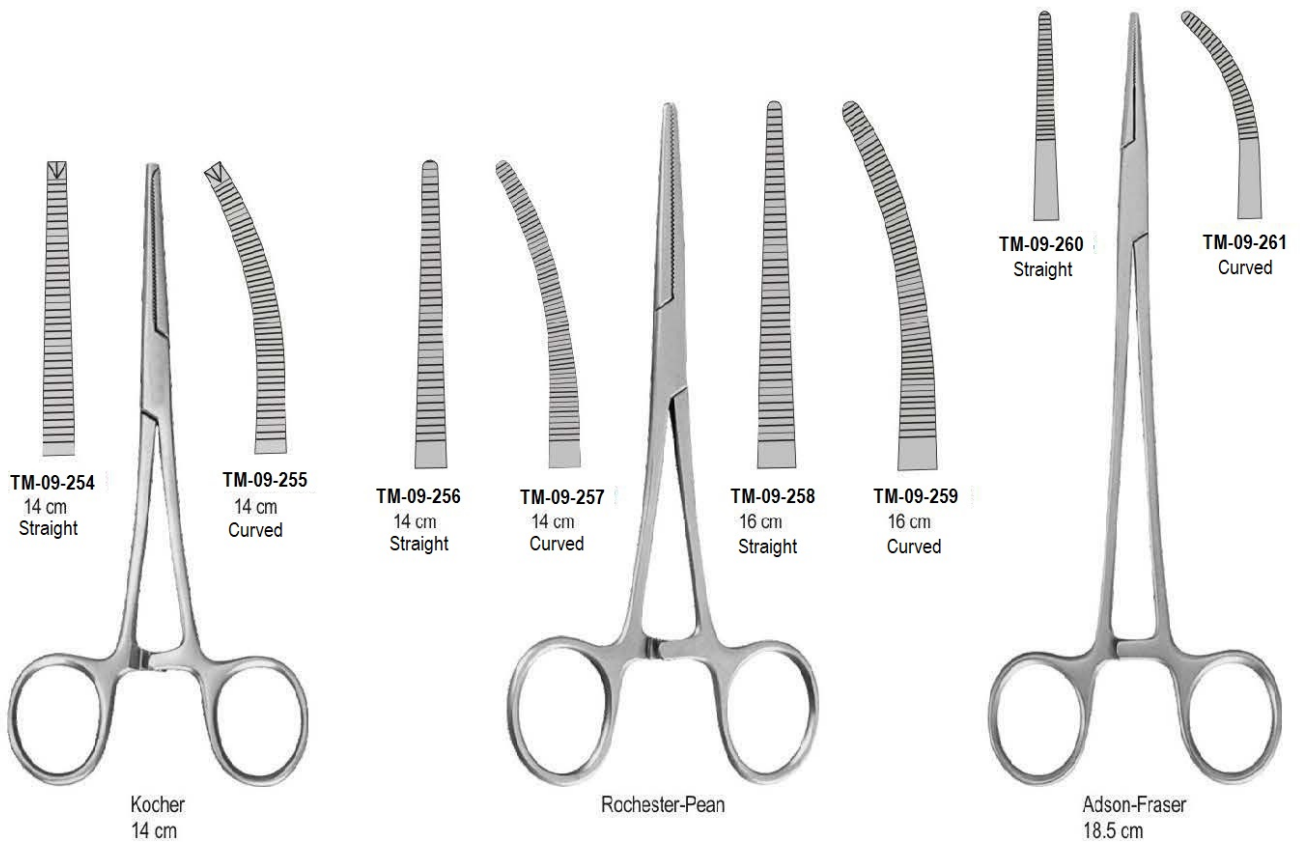
Jones Towel
TM-08-244
9 cm

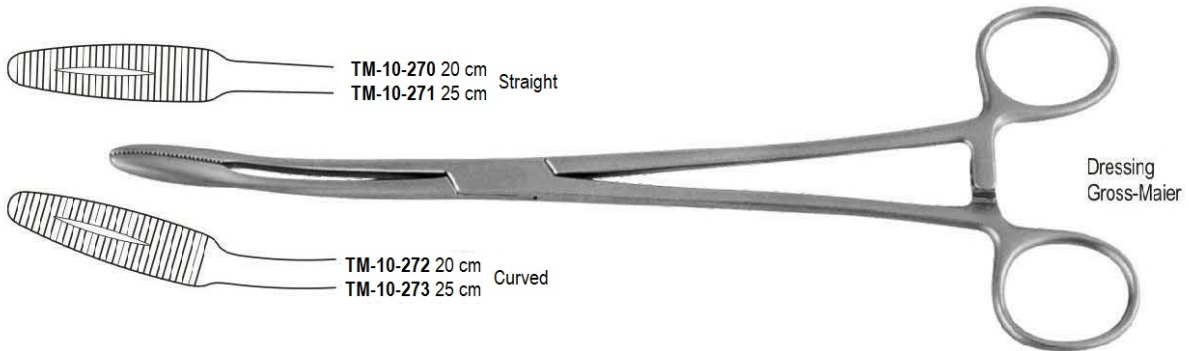
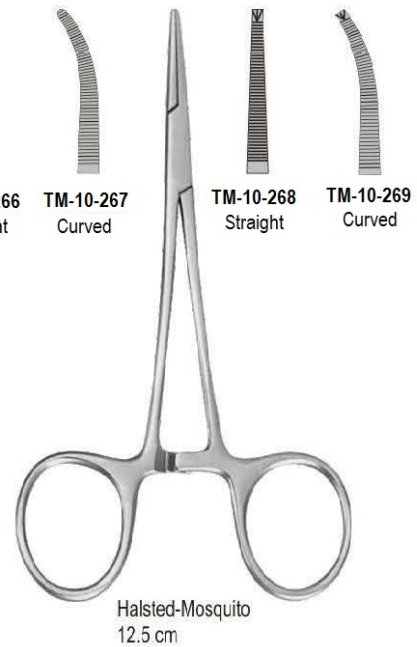
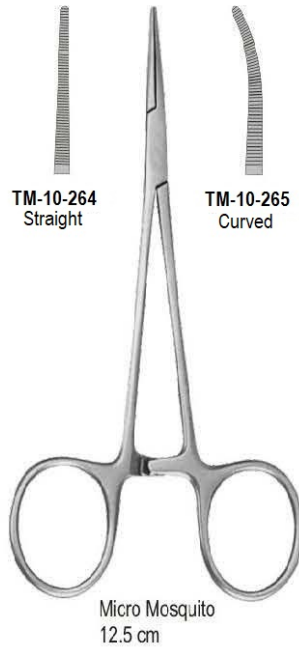


Schaedel Towel
TM-08-245
9 cm



Dressing Forceps Scissors







Needle Holder



TM-11-276
Derf
12.5 cm

TM-11-277
Olsen-Hegar
14 cm

TM-11-278
Baumgartner
14.5 cm

TM-11-279
Crilewood
15 cm

Mayo-Hegar
TM-11-280 14 cm
TM-11-281 15 cm
TM-11-282 16 cm
TM-11-283 18 cm
TM-11-284 20 cm



Mathieu

TM-11-285 14 cm
TM-11-286 17 cm
TM-11-287 20 cm



Mathieu-Kocher

TM-11-288 14 cm
TM-11-289 17 cm



Mathieu

TM-11-290 14 cm
TM-11-291 17 cm



Mathieu

TM-11-292 14 cm
TM-11-293 17 cm



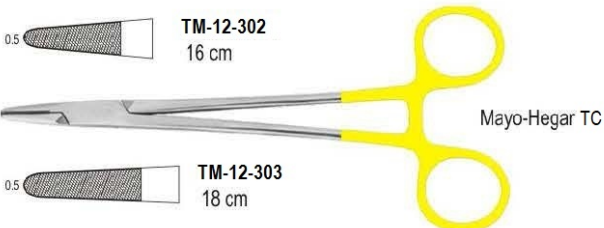
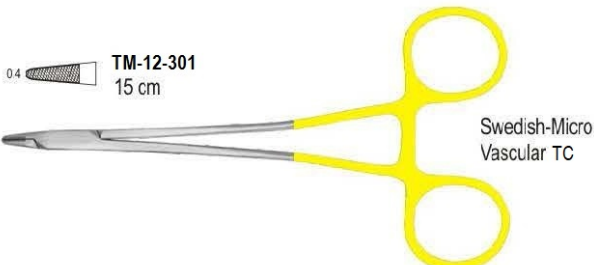
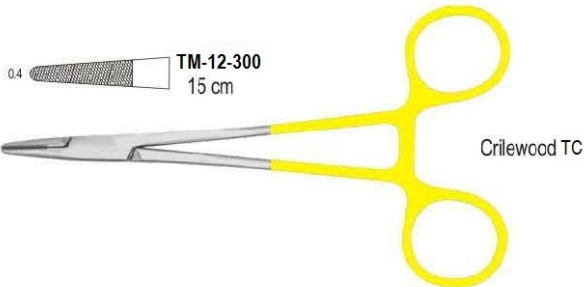
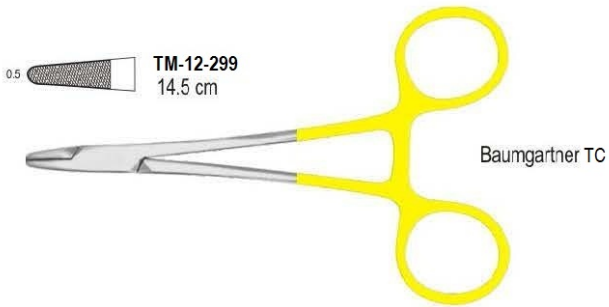
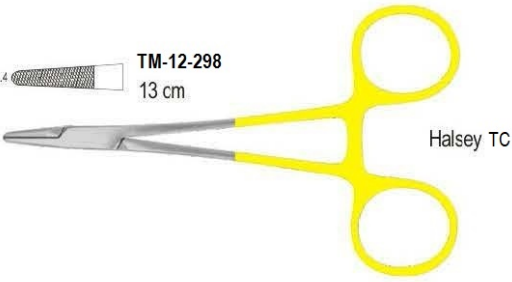
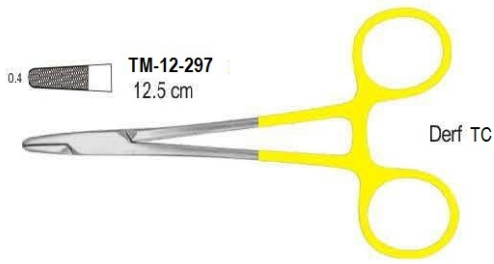
Boynton

TM-11-294
12 cm



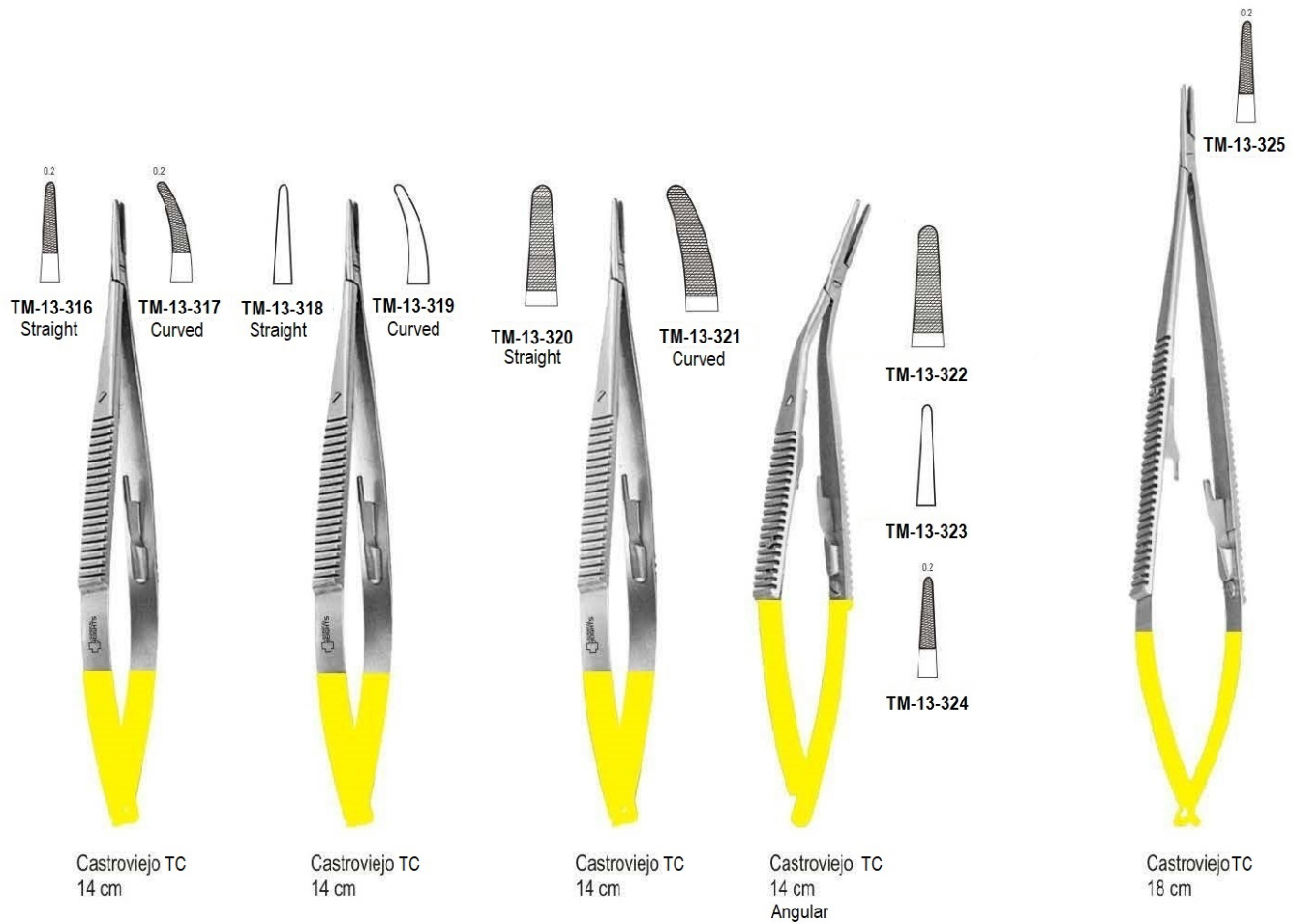
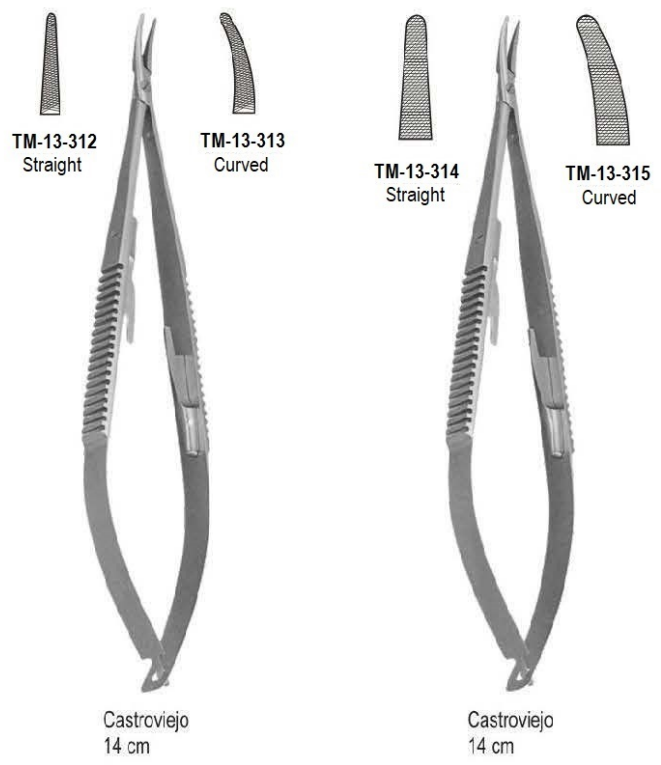
Gillies with Scissor

TM-11-295 Left handed
TM-11-296 Right handed
16 cm



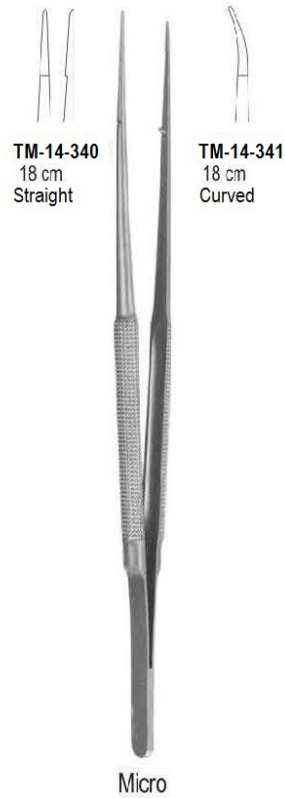
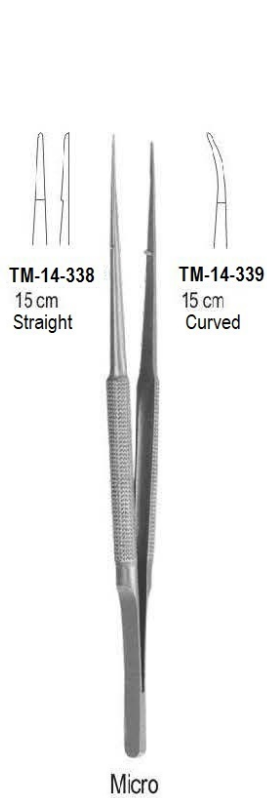


Needle Holder





Dressing Forceps Tweezwes





Page 15-33

- TOOTH EXTRACTION FORCEPS



Extracting English Pattern

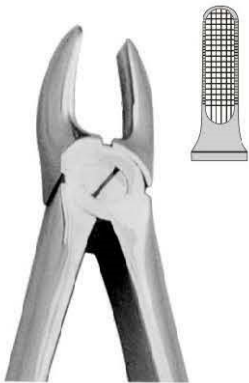


Fig. 1
TM-15-01
Upper Centrals & Canines / Cuspids



Fig. 2
TM-15-02
Upper Laterals & Canines / Cuspids

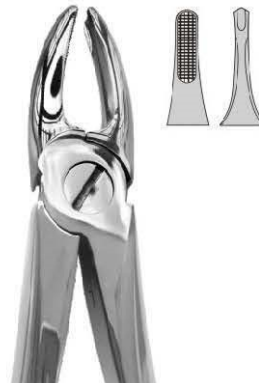


Fig. 3
TM-15-03
Upper Incisors & Canines



Fig. 4
TM-15-04
Lower Incisors & Cuspids



Fig. 7
TM-15-07
Upper Premolars / Bicuspids

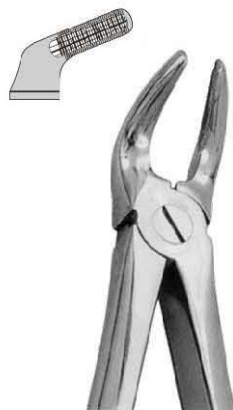


Fig. 8
TM-15-08
Lower Premolars / Bicuspids



Fig. 13
TM-15-13
Upper Molars

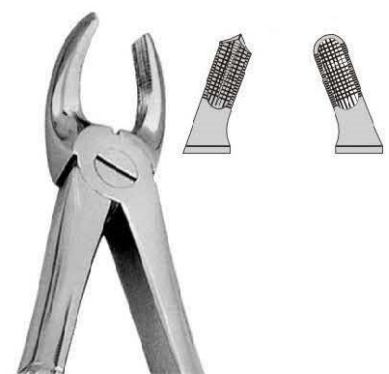


Fig. 17
TM-15-17
Upper Molars, Left



Fig. 18
TM-15-18
Upper Molars, Right



Fig. 18A
TM-15-18A
Upper Molars



Fig. 19
TM-15-19
Upper Third Molars



Fig. 21
TM-15-21
Lower Molars

Extracting English Pattern



Fig. 22
TM-16-22
Lower Molars

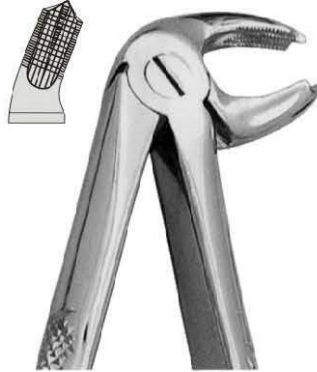


Fig. 23
TM-16-23
Lower Molars
Right



Fig. 24
TM-16-24
Lower Molars
Left

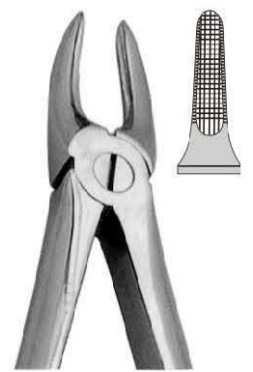


Fig. 29
TM-16-29
Upper Roots

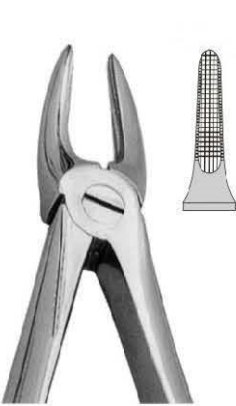


Fig. 29N
TM-16-29N
Upper Roots



Fig. 30
TM-16-30
Upper Roots

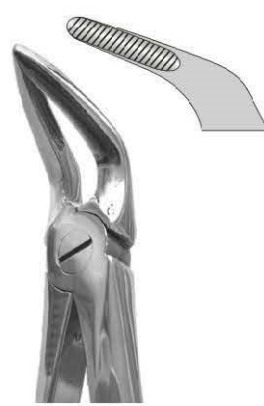


Fig. 31
TM-16-31
Upper Roots



Fig. 32
TM-16-32
Lower Molars



Fig. 33
TM-16-33
Lower Roots



Fig. 33A
TM-16-33A
Lower Roots



Fig. 33M
TM-16-33M
Lower Roots



Fig. 41
TM-16-41
Upper Roots



Extracting English Pattern

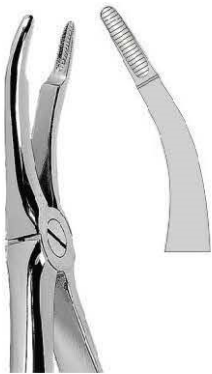


Fig. 44
TM-17-44
Upper Roots



Fig. 45
TM-17-45
Lower Roots

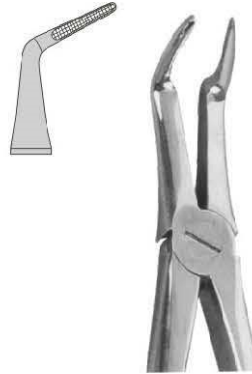


Fig. 46L
TM-17-46L
Lower Roots

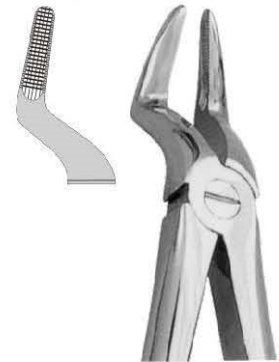


Fig. 51
TM-17-51
Upper Roots

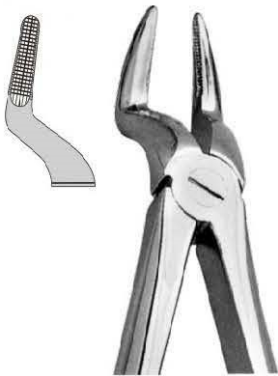


Fig. 51A
TM-17-51A
Upper Roots

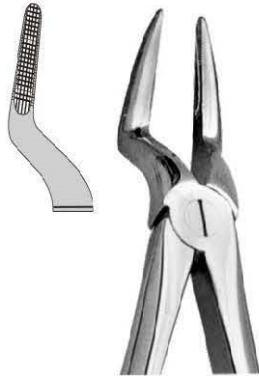


Fig. 51M
TM-17-51M
Upper Roots



Fig. 52
TM-17-52
Upper Roots



Fig. 52A
TM-17-52A
Upper Teeth
& Resection



Fig. 55
TM-17-55
For Separating
Upper Molars



Fig. 56
TM-17-56
For Separating
Lower Molars



Fig. 67
TM-17-67
Upper Third
Molars

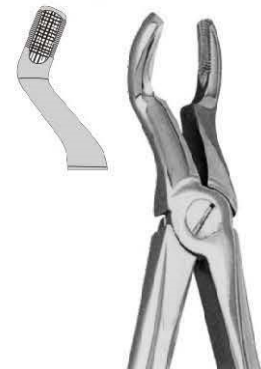


Fig. 67A
TM-17-67A
Upper Third
Molars

Extracting English Pattern


Fig. 91
TM-18-91
For Separating
Lower Molars



Fig. 99
TM-18-99
Lower Molars



Fig. 99 1/4
TM-18-990
Lower Molars



Fig. 99 1/2
TM-18-991
Lower Molars

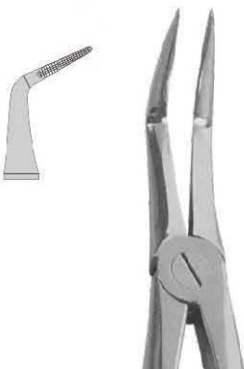


Fig. 145
TM-18-145
Very Fine Roots
Lower



Fig. 151 1/2
TM-18-151
Very Fine Roots
Upper

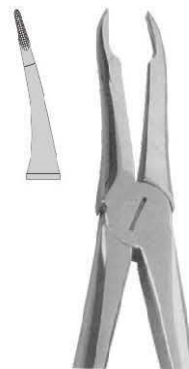


Fig. 349
TM-18-349
Very Fine Roots
Upper



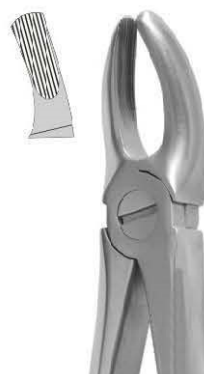
Fig. 359
TM-18-359
Very Fine Roots
Lower



MD 1
TM-18-MD1
Incisors, Bicuspid & Roots
Upper



MD 3
TM-18-MD3
Incisors, Bicuspid & Roots
Lower



MD 2
TM-18-MD2
Upper Molars



MD 4
TM-18-MD4
Lower Molars



Extracting English Pattern



Fig. 68
TM-19-68
Lower Roots



Fig. 68A
TM-19-68A
Lower Roots



Fig. 73
TM-19-73
Lower Molars



Fig. 74
TM-19-74
Lower Roots



Fig. 74N
TM-19-74N
Lower Roots



Fig. 75
TM-19-75
Lower Premolars / Bicuspid



Fig. 79
TM-19-79
Lower Third Molars



Fig. 79A
TM-19-79A
Lower Third Molars



Fig. 86A
TM-19-86A
Lower Molars



Fig. 86C
TM-19-86C
Lower Molars



Fig. 87
TM-19-87
Lower Molars



Fig. 89
TM-19-89
Right Upper Molars



Fig. 90
TM-19-90
Left Upper Molars

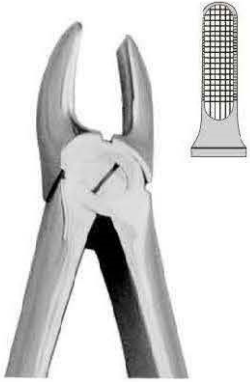
Extracting English Pattern


Fig. 1
TM-20-01
Upper Centrals &
Canines / Cuspids

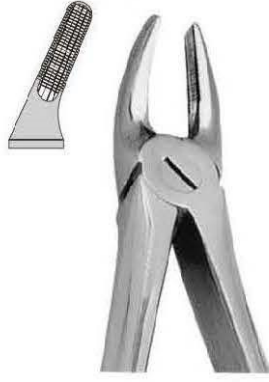


Fig. 7
TM-20-07
Upper Premolars / Bicuspid



Fig. 13
TM-20-13
Upper Molars, Right



Fig. 17
TM-20-17
Upper Molars, Left

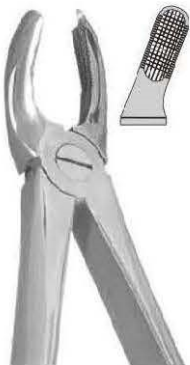


Fig. 18
TM-20-18
Upper Molars



Fig. 22
TM-20-22
Lower Molars



Fig. 33
TM-20-33
Lower Roots

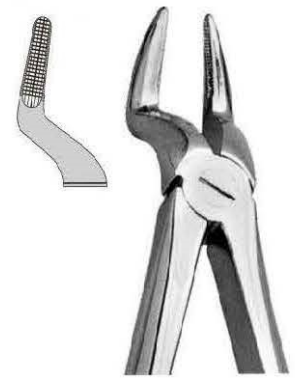


Fig. 51A
TM-20-51A
Upper Roots



Fig. 67A
TM-20-67A
Upper Third
Molars

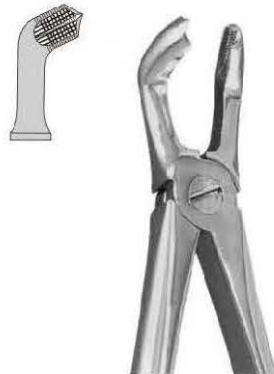


Fig. 79
TM-20-79
Lower Third Molars



TM-20-10S
Set of 10 pieces



Extracting English Pattern Children



Fig.3
TM-21-03S
Lower Premolars

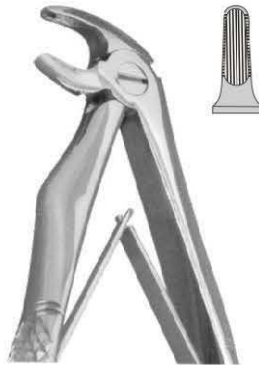


Fig.5
TM-21-05S
Lower Roots

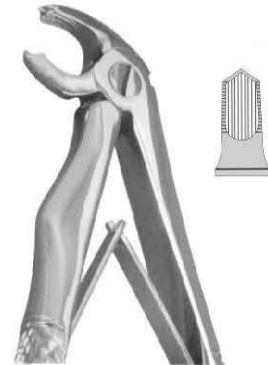


Fig.6
TM-21-06S
Lower Roots



Fig.7
TM-21-07S
Upper Incisors

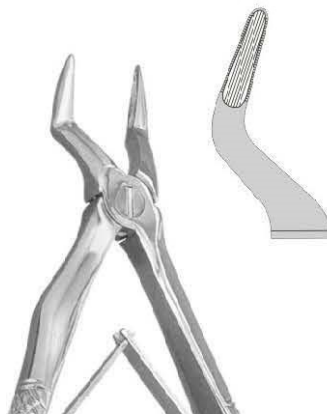


Fig.51S
TM-21-51S
Lower Incisors and Canines

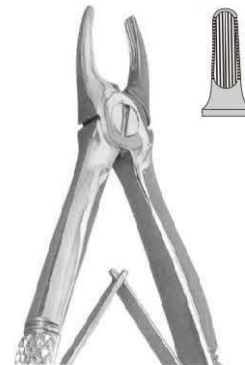


Fig.137
TM-21-137S
Upper Molars, left

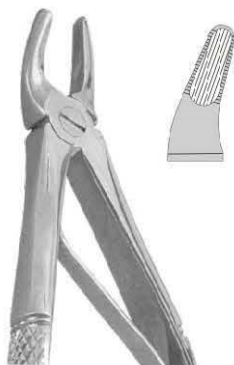


Fig.139
TM-21-139S
Upper Molars, Right



TM-21-007S
Set of 7 pieces

Extracting Anatomical Grip

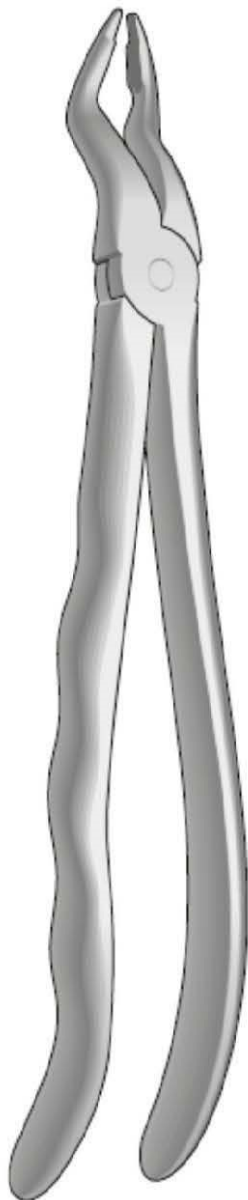


Fig. S-31
TM-22-S31
Upper Premolars

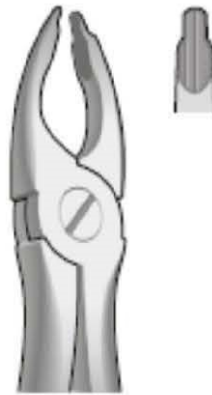


Fig.34
TM-22-34
Upper Incisors & Cuspids



Fig.35
TM-22-35
Upper Incisors & Cuspids,
Deep Gripping

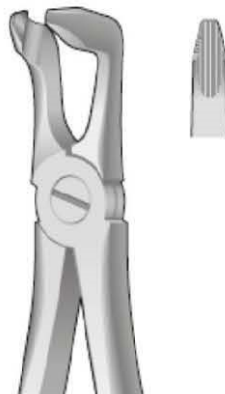


Fig. 79N
TM-22-79N
Lower Wisdom Teeth



Fig. 46N
TM-22-46N
Lower Premolars



Fig.36
TM-22-36
Lower roots
Incisors & Cuspids



Fig.36N
TM-22-36N
Lower roots
Incisors & Cuspids



Fig.59
TM-22-59
Lower Root Fragments





Extracting Anatomical Grip

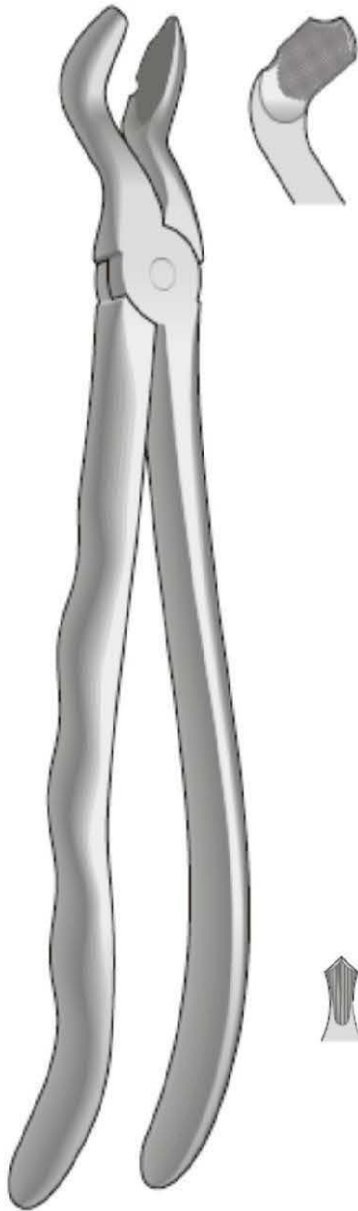


Fig. 80
TM-23-80
Felsch
Upper Wisdom Teeth
with Retaining Device

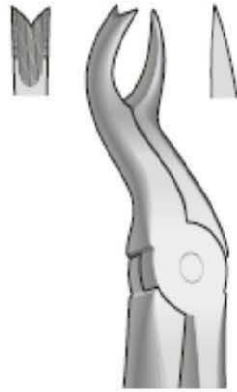


Fig. 67L
TM-23-67L
Upper Molars
Left



Fig. 67R
TM-23-67R
Upper Molars
Right

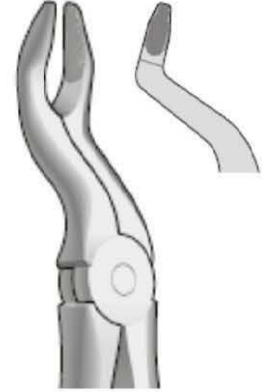


Fig. 67N
TM-23-67N
Upper Molars

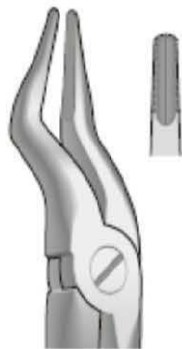


Fig. 51B
TM-23-51B
Upper Molars

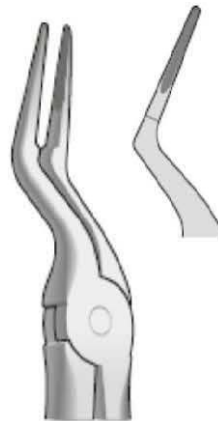


Fig. 97
TM-23-97
Upper Root Fragments

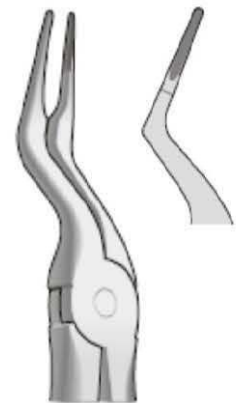


Fig. 97B
TM-23-97B
Upper Root Fragments



Fig. 122 L
TM-23-122L
Lower Molars & Wisdom Teeth
Left



Fig. 122 R
TM-23-122R
Lower Molars & Wisdom Teeth
Right



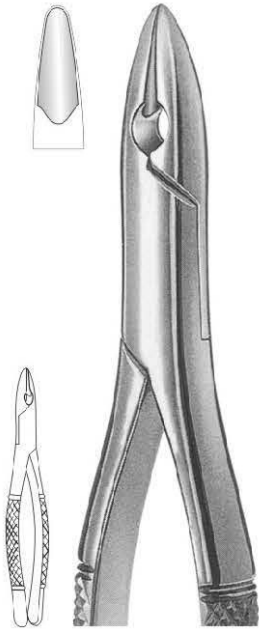
Fig. 133 L
TM-23-133L
Lower Very Fine Roots
Left



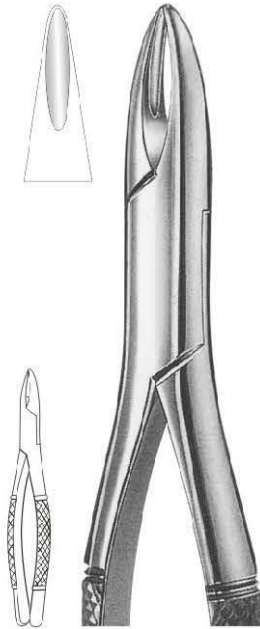
Fig. 133 R
TM-23-133R
Lower Very Fine Roots
Right



Extracting American Pattern



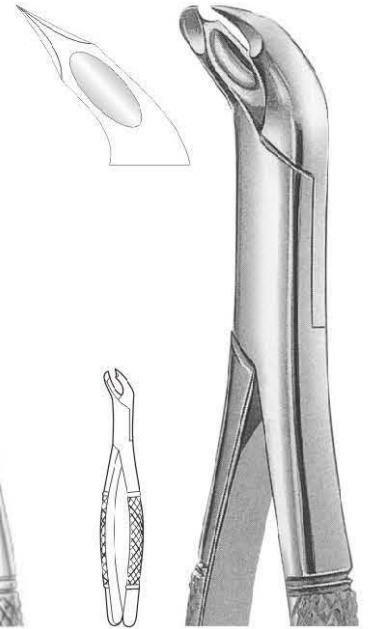
Standard # 1
TM-24-01
For upper incisors & cuspids



Henahan # 1 A
TM-24-1A
For upper incisors



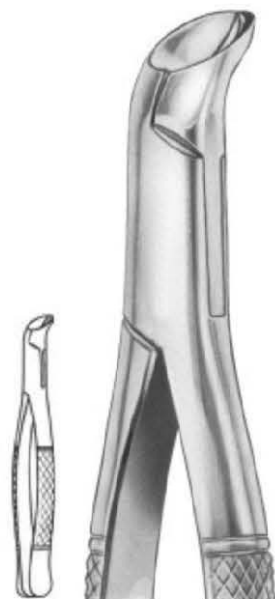
2
TM-24-02
Upper & Lower Roots



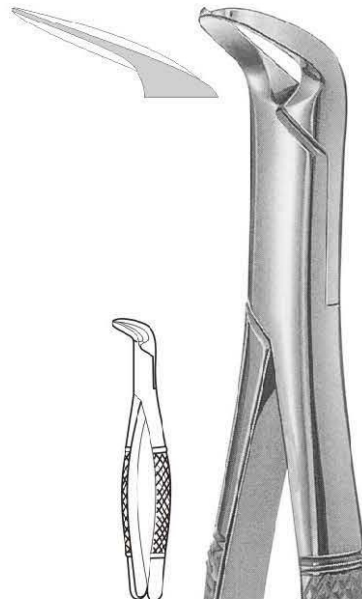
Woodward # 3 FS
TM-24-3FS
For lower molars



4
TM-24-04
Upper & Lower Premolars



Physick # 5
TM-24-05
Lower third molars



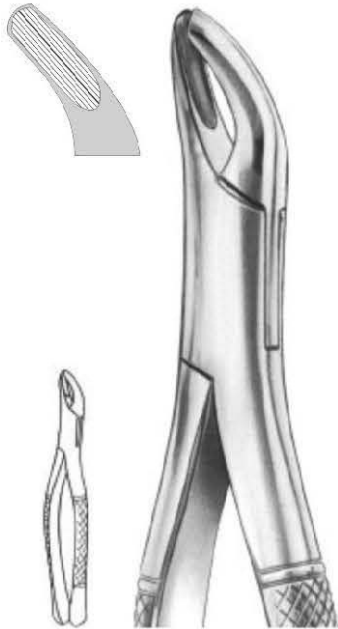
Spalitzange # 6
TM-24-06
Splitting & Separating Forceps



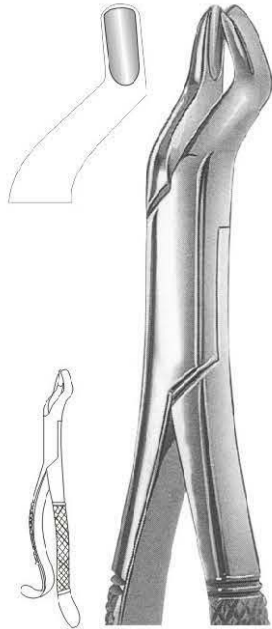
7
TM-24-07
Upper Roots



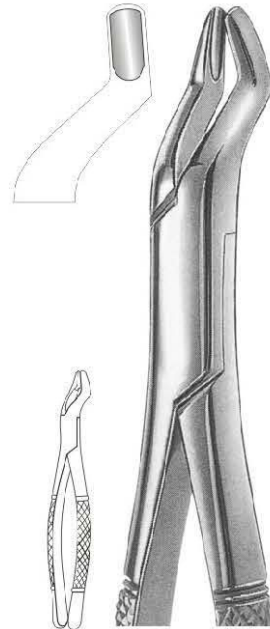
Extracting American Pattern



TM-25-08 # 8
Upper & Lower third molars



TM-25-10H # 10 H
For upper Molars, Hook Handle



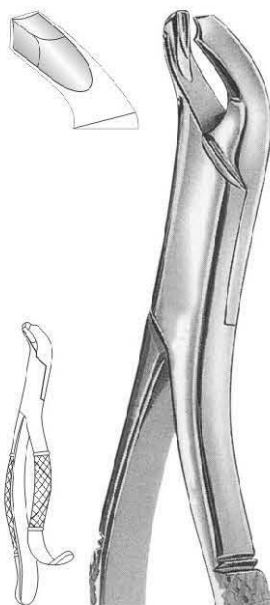
TM-25-10S # 10S
For upper Molars



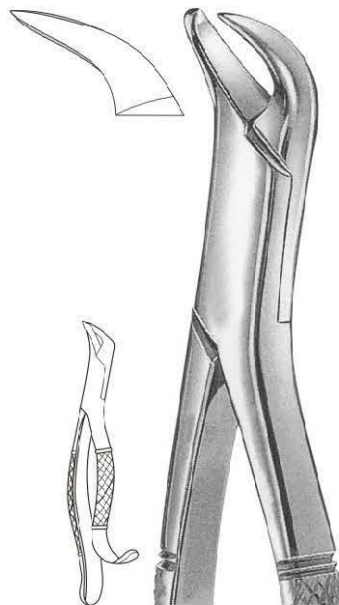
TM-25-13 # 13
Upper Incisors



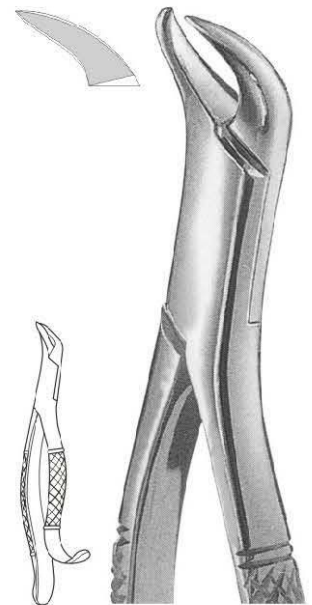
TM-25-14 # 14
Lower Incisors



TM-25-15 # 15
For 1st & 2nd Lower Molars



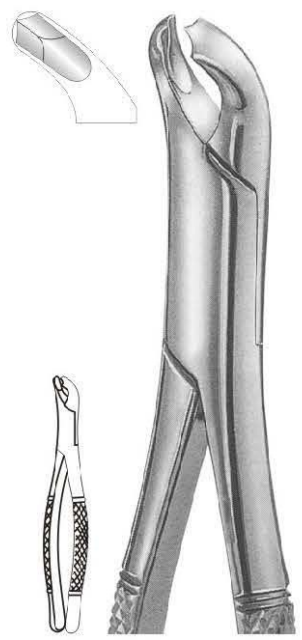
"Cow Horn"
TM-25-16 # 16
for 1st & 2nd Lower Molars



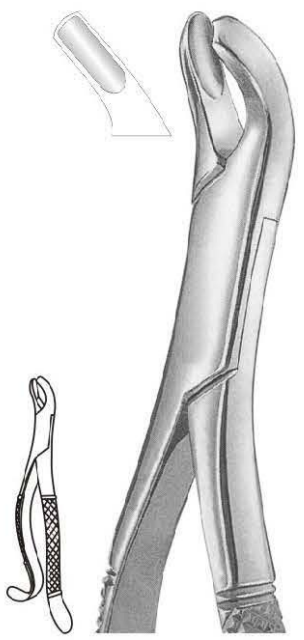
"Cow Horn"
TM-25-16SK # 16 SK
for children, for Lower Molars



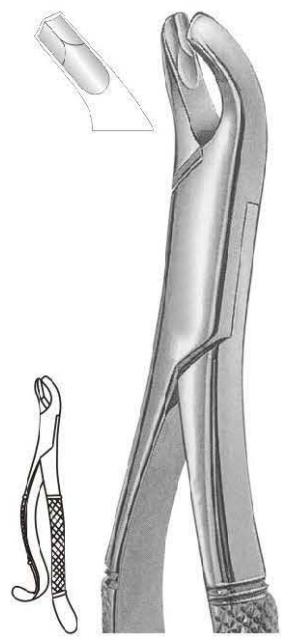
Extracting American Pattern



TM-26-17 # 17
TM-26-17G # 17 Gold Plated
for 1st & 2nd Lower Molars



TM-26-18L # 18 L
for 1st & 2nd Upper Molars, left



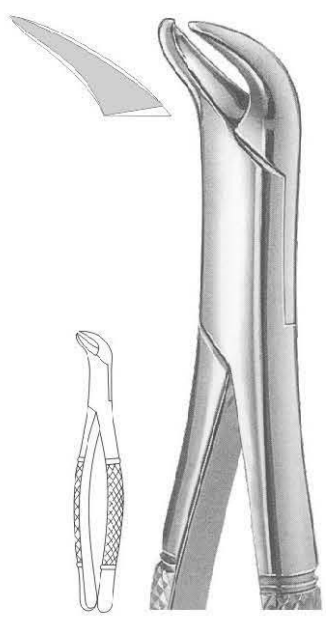
TM-26-18R # 18 R
for 1st & 2nd Upper Molars, right



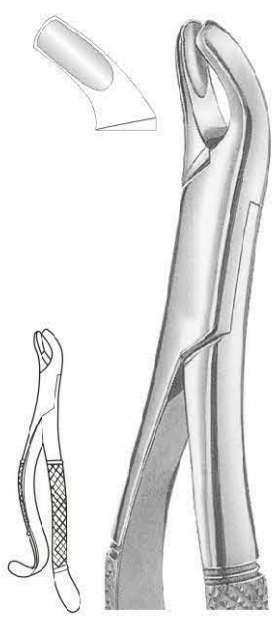
TM-26-20L # 20 L
Upper Molars left.



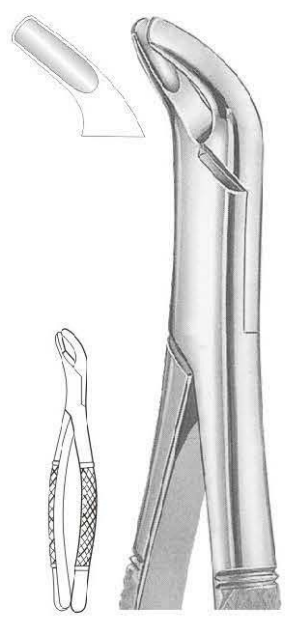
TM-26-20R # 20 R
Upper Molars right



"Cow Horn"
TM-26-23 # 23
for Lower Molars



TM-26-24 # 24
for Upper Molars



TM-26-27 # 27
for Upper Molars



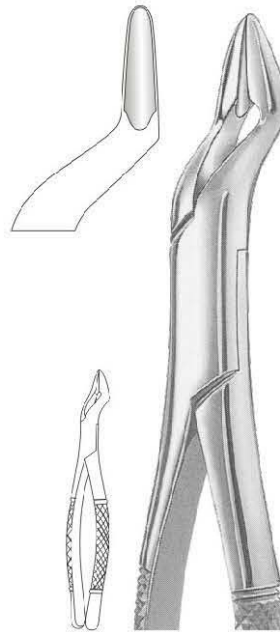
Extracting American Pattern



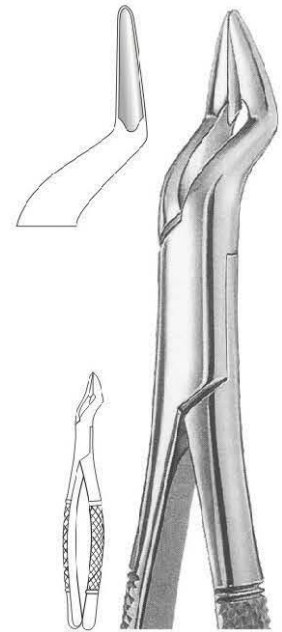
TM-27-29S # 29 S
Lower teeth for children



TM-27-30S # 30 S
Upper teeth for children



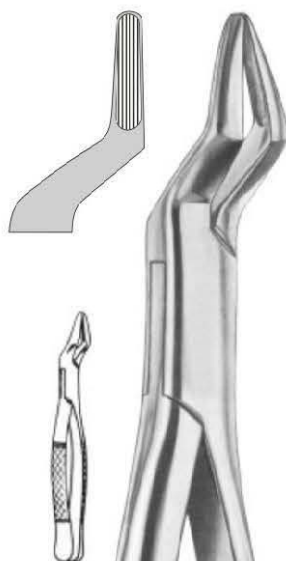
TM-27-32 # 32
for Upper Bicuspids



Parmly
TM-27-32A # 32 A
for upper Bicuspids & Roots



TM-27-34 # 34
Lower Anteriors & Roots



TM-27-35 # 35
Upper Roots



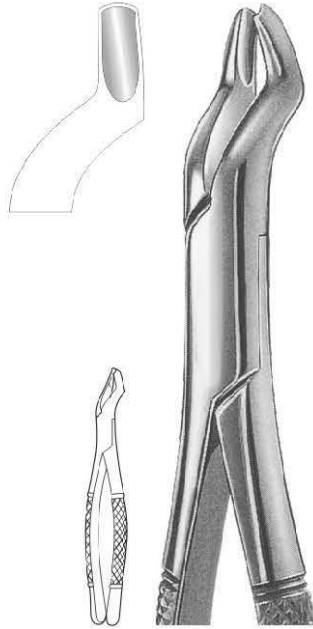
TM-27-36 # 36
Lower Anteriors & Roots



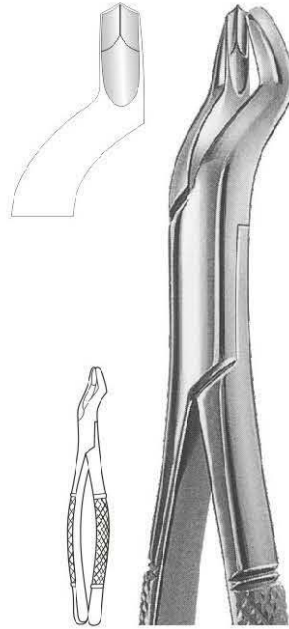
TM-27-37 # 37
Lower Anteriors & Roots

Extracting American Pattern

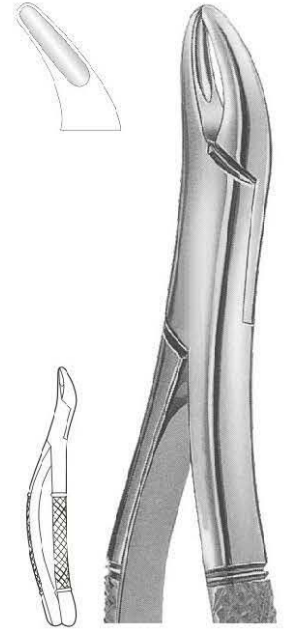

TM-28-38 # 38
Upper Anteriors & Roots



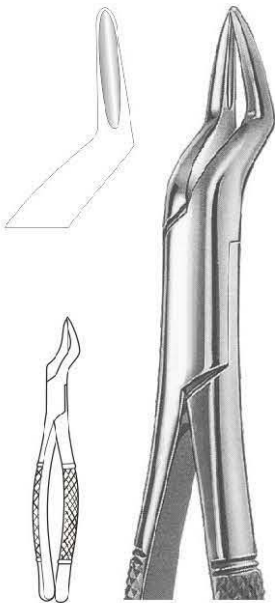
TM-28-53L # 53 L
TM-28-53LG # 53 L Gold Plated
for upper Molars, left



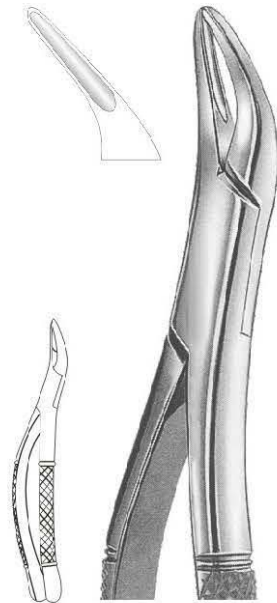
TM-28-53R # 53 R
TM-28-53RG # 53R Gold Plated
for upper Molars, right



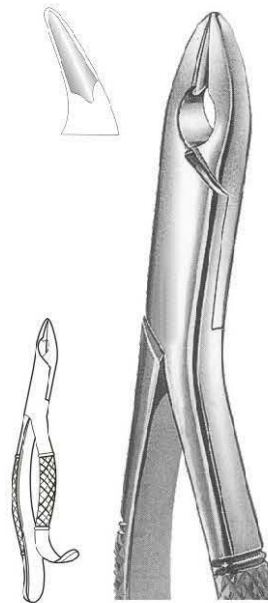
TM-28-62 # 62
for upper & Lower Incisors



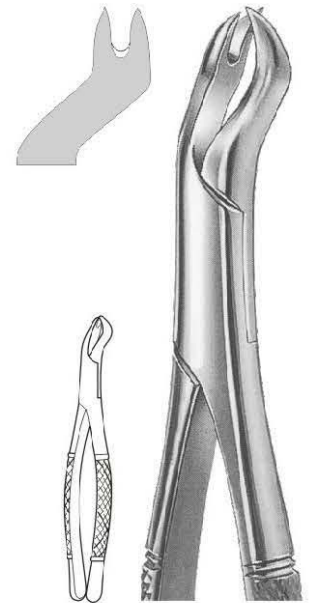
TM-28-65 # 65
TM-28-65G # 65 Gold Plated
for upper Incisors, Roots & Fragments



TM-28-69 # 69
TM-28-69G # 69 Gold Plated
for upper & Lower Fragments & Roots



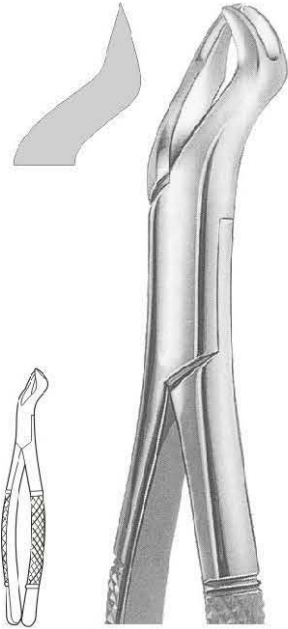
TM-28-85A # 85 A
for Lower Molars & Bicuspids



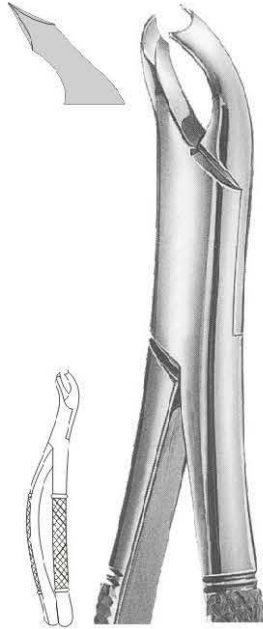
Nevius
TM-28-88L # 88 L
for Upper Molars, left



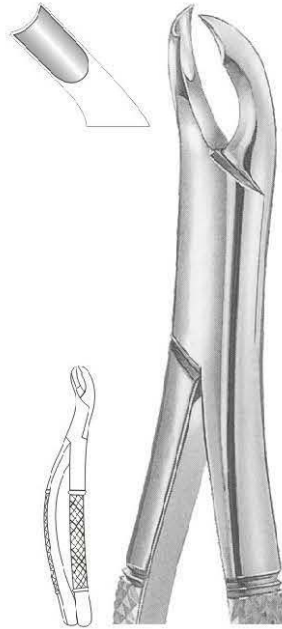
Extracting American Pattern



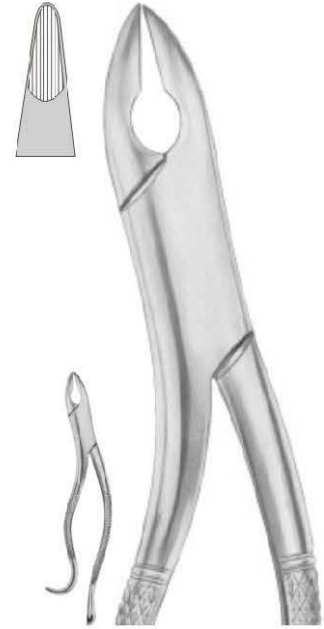
Nevius
TM-29-88R # 88 R
For upper Molars, right



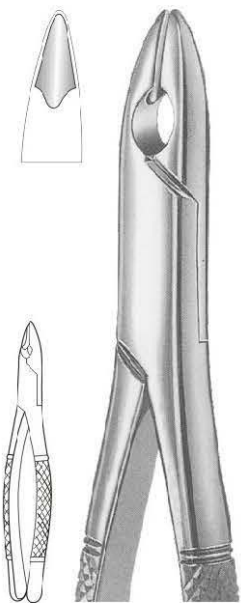
TM-29-89 # 89
For upper Molars, right



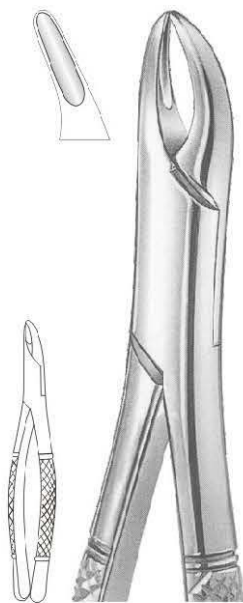
TM-29-90 # 90
For upper Molars, left



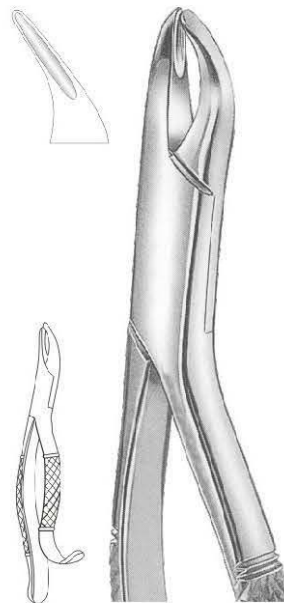
Kells
TM-29-99A # 99 A
Upper Incisors, Canines, Premolars



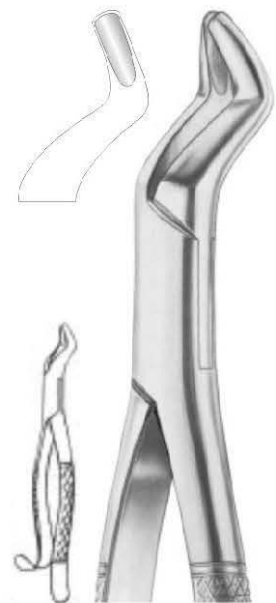
Kells
TM-29-99C # 99 C
For upper Incisors & Bicuspids



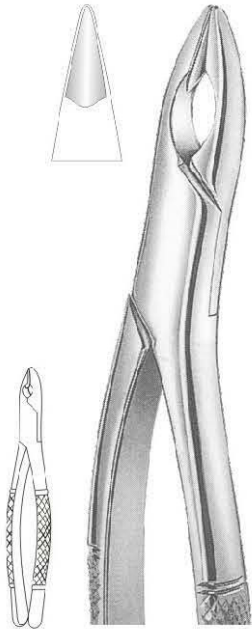
Hull
TM-29-101 # 101
Universal for Bicuspids & Deciduous



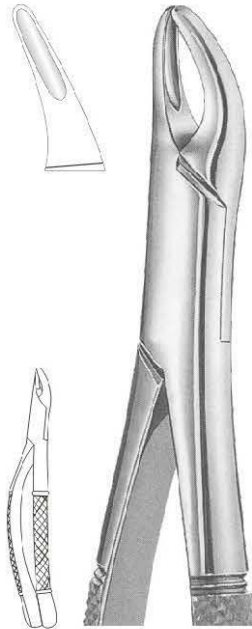
TM-29-103 # 103
for Lower Incisors, Bicuspids & Roots



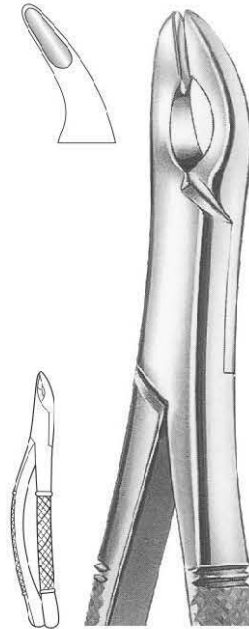
TM-29-104 # 104
Upper third molars

Extracting American Pattern


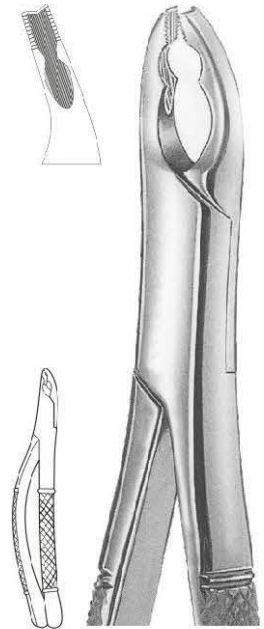
Nevius
TM-30-110S # 110 S
 for Upper Bicuspid & Cuspids



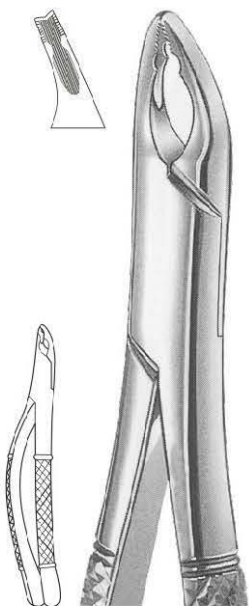
Cryer
TM-30-150 # 150
TM-30-150G # 150 Gold Plated
 for Upper Incisors, Bicuspid & Roots



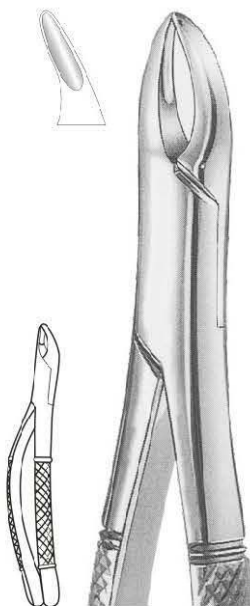
Cryer
TM-30-150A # 150 A
 For upper Incisors, Cuspids & Bicuspid



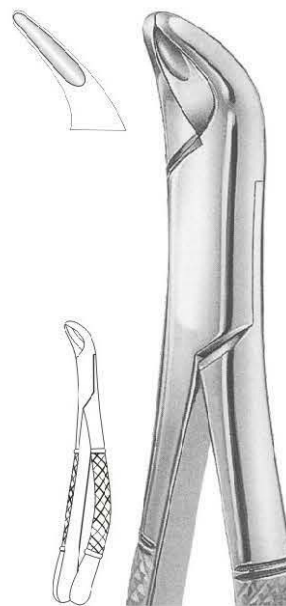
Cryer
TM-30-150AS # 150 AS
 For upper Incisors, Cuspids
 serrated jaw



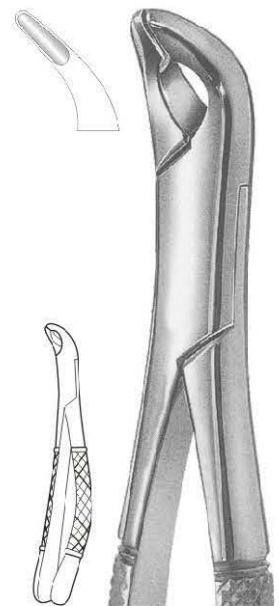
Cryer
TM-30-150XAS # 150 XAS
 For children, for Upper Incisors &
 Cuspids, serrated jaw



Cryer
TM-30-150S # 150 S
TM-30-150SG # 150 S Gold Plated
 For children, for Upper Incisors, Bicuspid & Roots



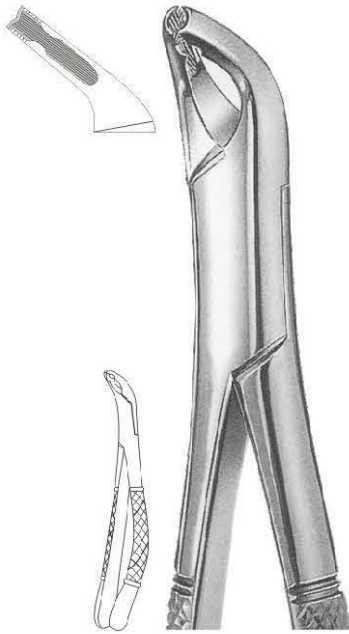
Cryer
TM-30-151 # 151
TM-30-151G # 151 Gold Plated
 For Lower Incisors, Bicuspid & Roots



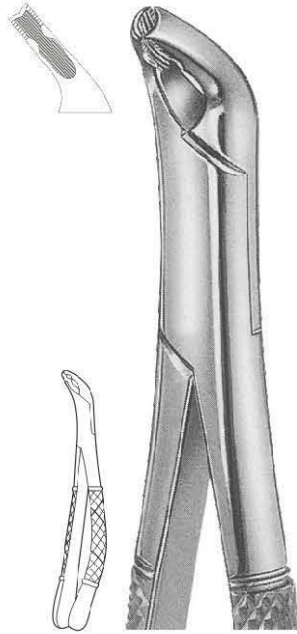
Cryer
TM-30-151A # 151 A
 For Lower Incisors, Cuspids
 & Bicuspid



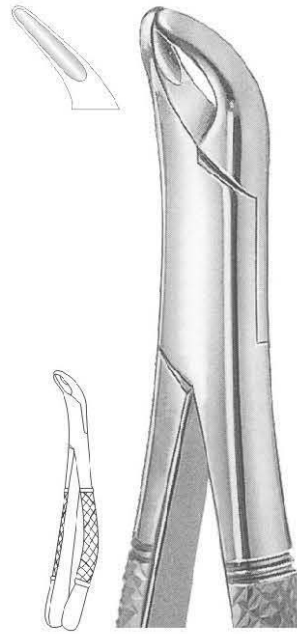
Extracting American Pattern



Cryer
TM-31-151AS # 151 AS
For Lower Incisors & Cuspids, serrated jaw



TM-31-151XAS # 151 XAS
For children, for Lower Incisors & Cuspids, serrated jaw



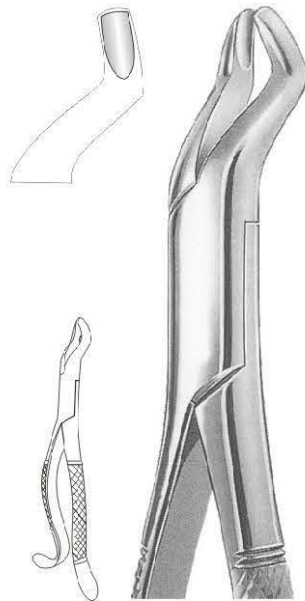
Cryer
TM-31-151S # 151 S
TM-31-151SG # 151 S Gold Plated
For children, for Lower incisors, Bicuspids & Roots



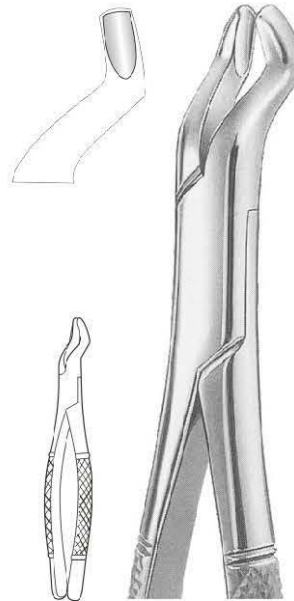
TM-31-201 # 201
Upper Incisors, Canines, premolars



TM-31-203 # 203
Lower Incisors & Roots



TM-31-210H # 210 H
For Upper Wisdoms, Hook Handle

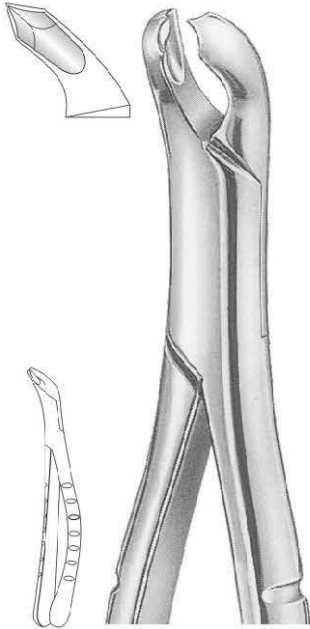


TM-31-210S # 210 S
For Upper Wisdoms

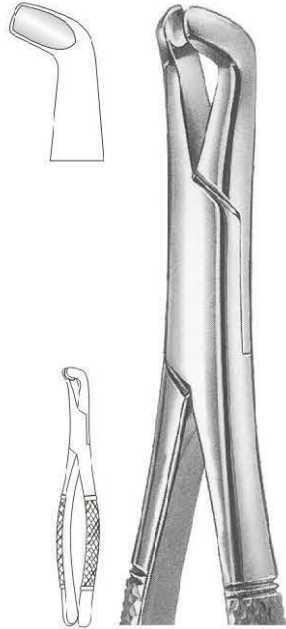


TM-31-213 # 213
Upper Centrals & Canines

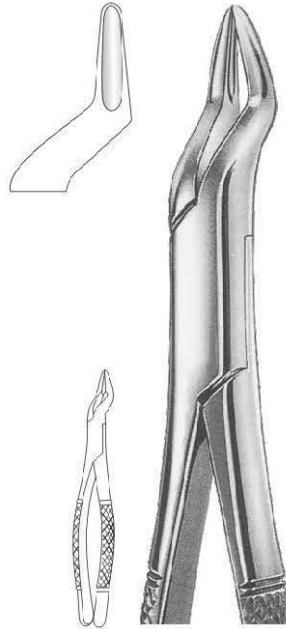
Extracting American Pattern



TM-32-217 # 217
For Lower Molars



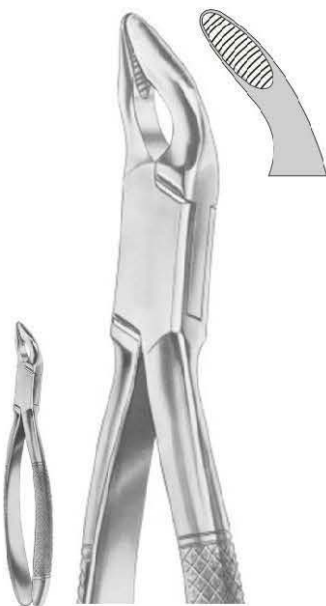
TM-32-222 # 222
For Lower Wisdoms



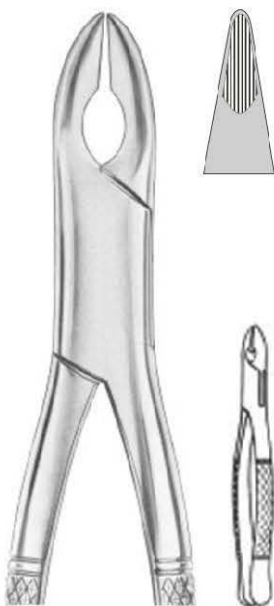
TM-32-286 # 286
For Upper Incisors, Bicuspid & Roots



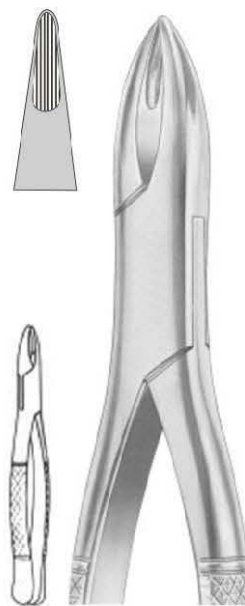
TM-32-288 # 288
Lower Canines & Premolars



Cohen
TM-32-310 # 310
Universal Forceps



Nevius
TM-32-320 # 320
Upper Canines



Henahan
TM-32-315 # 315
Upper Incisors



Nevius
TM-32-325 # 325
Upper Canines



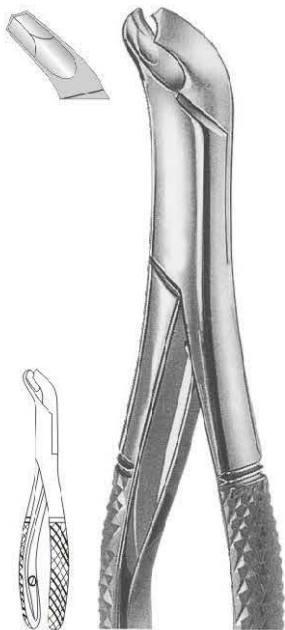
Extracting American Pattern



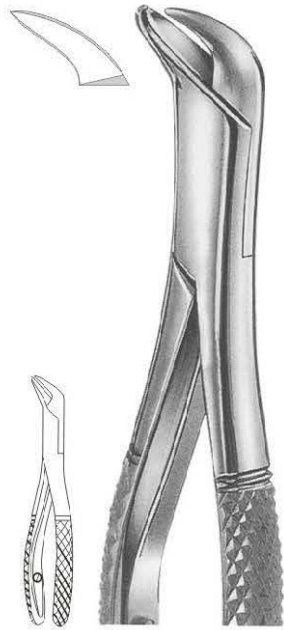
Standard
TM-33-330 # 330/4
Upper Third Molars



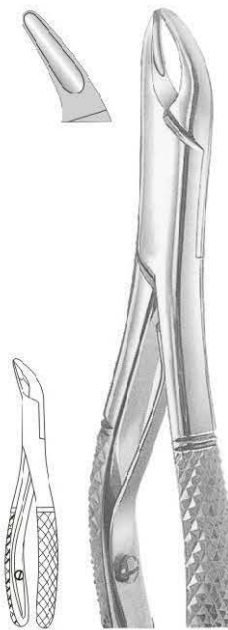
Woodward
TM-33-335 # 335/FH
Lower Molars



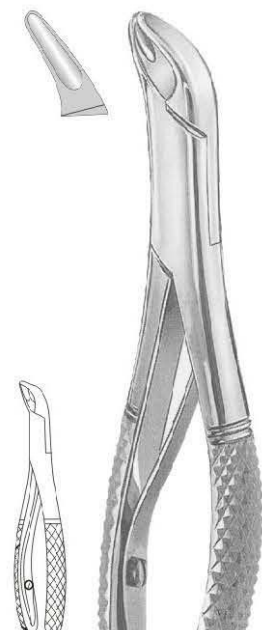
TM-33-17SK
17 SK
For children for Lower Wisdoms



TM-33-23SK
23 SK
For children for Lower Wisdoms



TM-33-150SK
150 SK
For Children, for Upper Incisors,
Bicuspid & Roots



TM-33-151SK
151 SK
For Children, for Lower Incisors,
Bicuspid & Roots



Page

34-73

- MOUTH MIRROR
- SCALPEL HANDL
- DENTAL PROBE
- PERIODONTAL CURETTE
- TISSUE FORCEPS ALLIGATOR
- TISSUE FORCEPS SCISSORS
- DENTAL DRESSING FORCEPS
- DENTAL SCALER
- DENTAL AMALGAM CARRIER
- DENTAL EXCAVATOR
- DENTAL WAX CARVER
- DENTAL SPATULA



Fig. 4
TM-34-400
Ø 22 mm
Rhodium coated front surface

Fig. 5
TM-34-401
Ø 24 mm

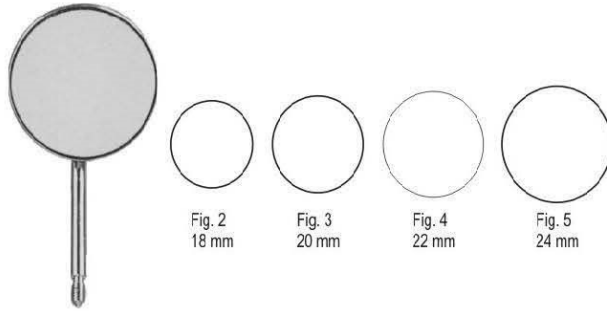


Fig. 2 18 mm
Fig. 3 20 mm
Fig. 4 22 mm
Fig. 5 24 mm

| | | Pack of 12 | | | |
|------|------|---------------|-----------|--------------|-----------|
| | | Front surface | | Rear surface | |
| Fig. | Ø mm | Chrome | Rhodium | Magnifying | Plane |
| 2 | 18 | - | - | | TM-34-409 |
| 3 | 20 | - | - | TM-34-406 | TM-34-410 |
| 4 | 22 | TM-34-402 | TM-34-404 | TM-34-407 | TM-34-411 |
| 5 | 24 | TM-34-403 | TM-34-405 | TM-34-408 | TM-34-412 |



Micro
Rhodium front surface

Fig. 000
TM-34-413
Ø 10 mm

Fig. 00
TM-34-414
Ø 12 mm

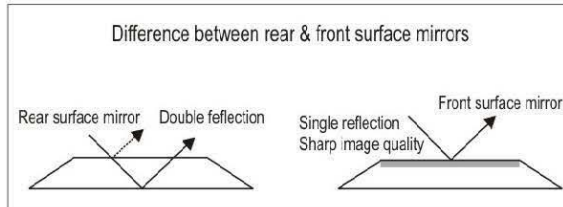


Fig. 1 TM-34-415
Fig. 2 TM-34-416
Fig. 3 TM-34-417
Fig. 4 TM-34-418
Solid Handle

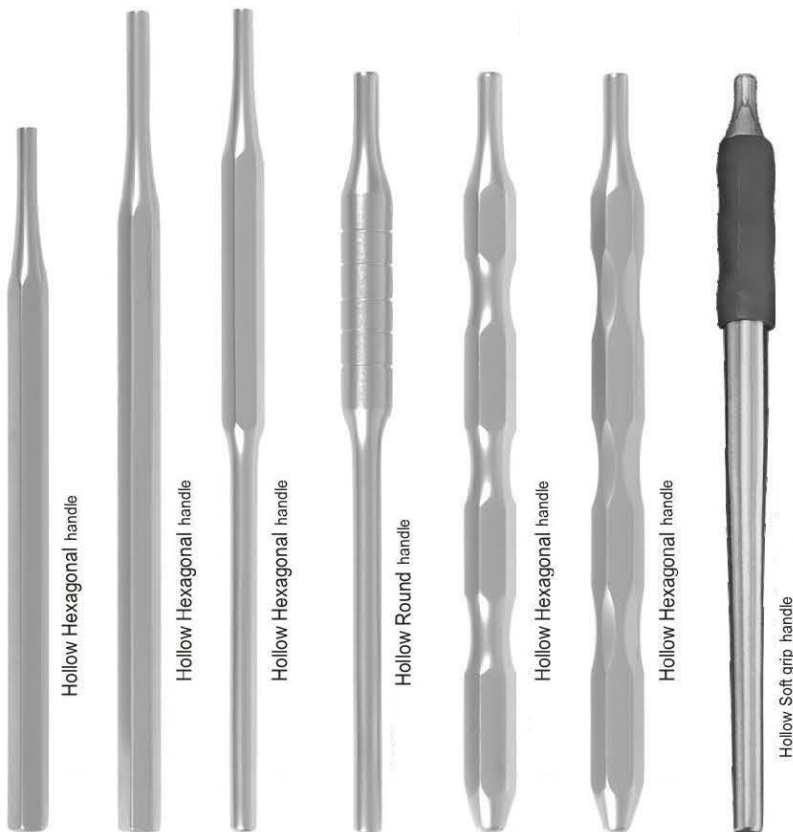
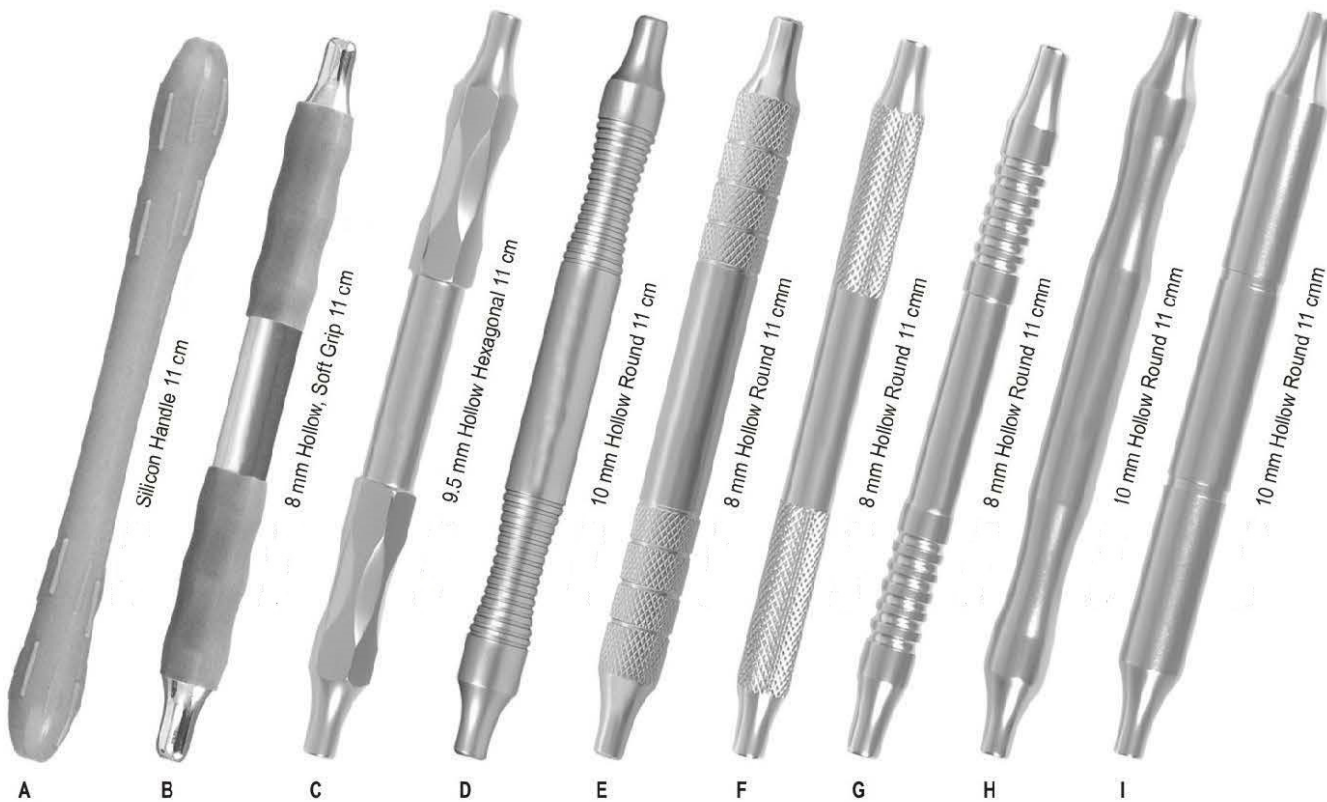


Fig. 1 TM-34-419
Fig. 2 TM-34-420
Fig. 3 TM-34-421
Fig. 4 TM-34-422
Fig. 5 TM-34-423
Fig. 6 TM-34-424
Fig. 7 TM-34-425



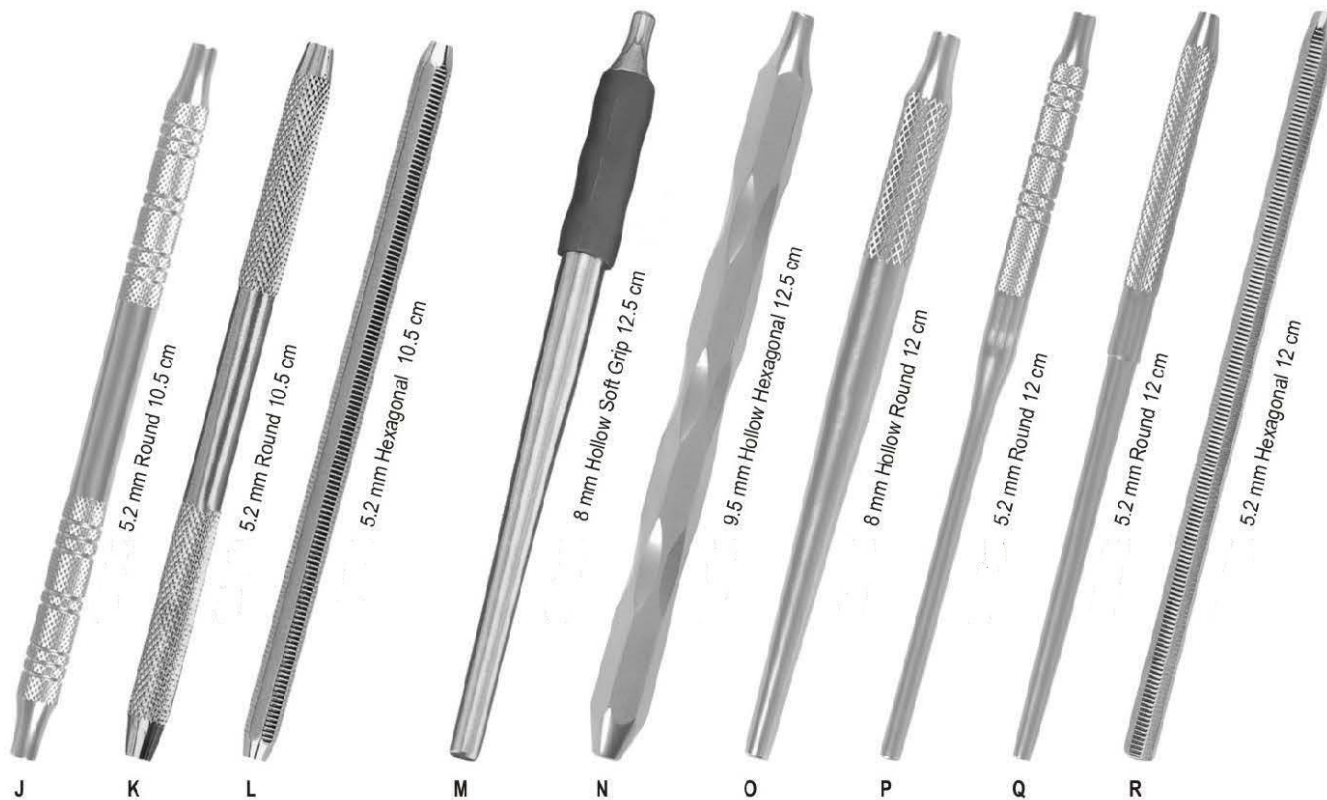
Handles Selection For Dental Scaler

Double Ended



Double Ended

Single Ended



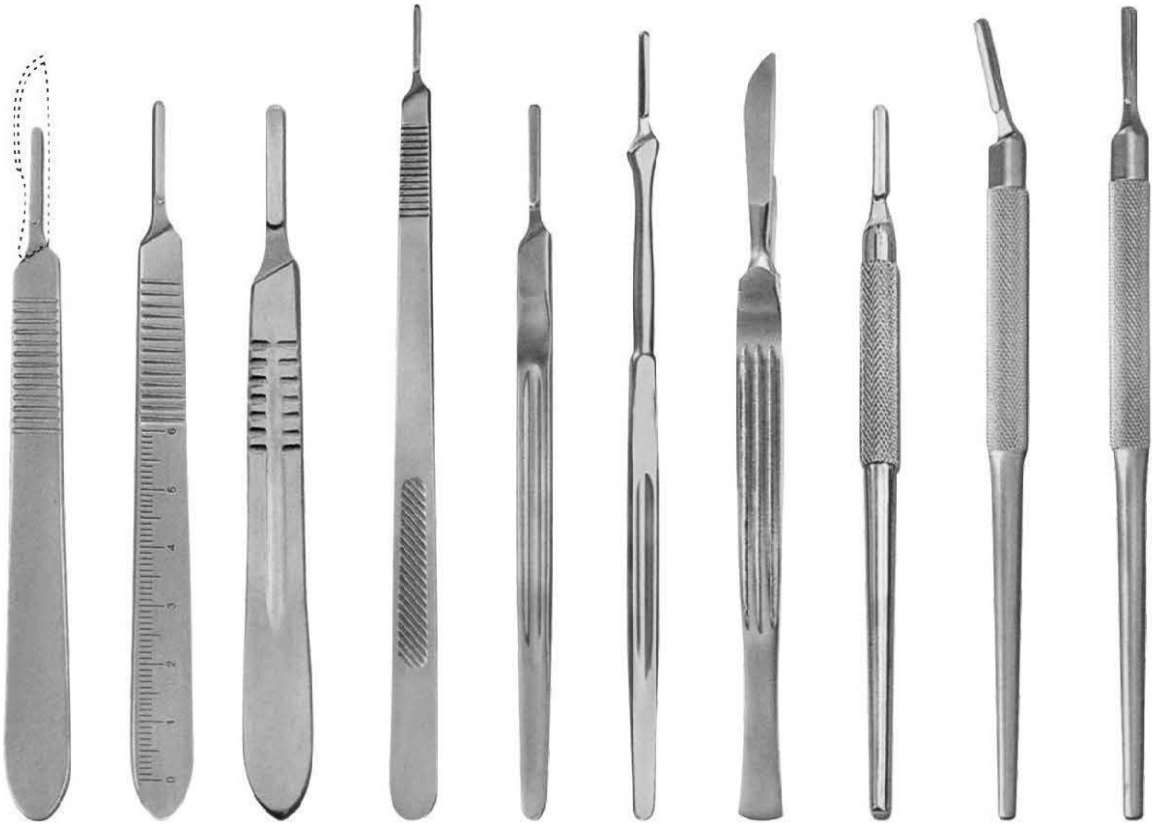
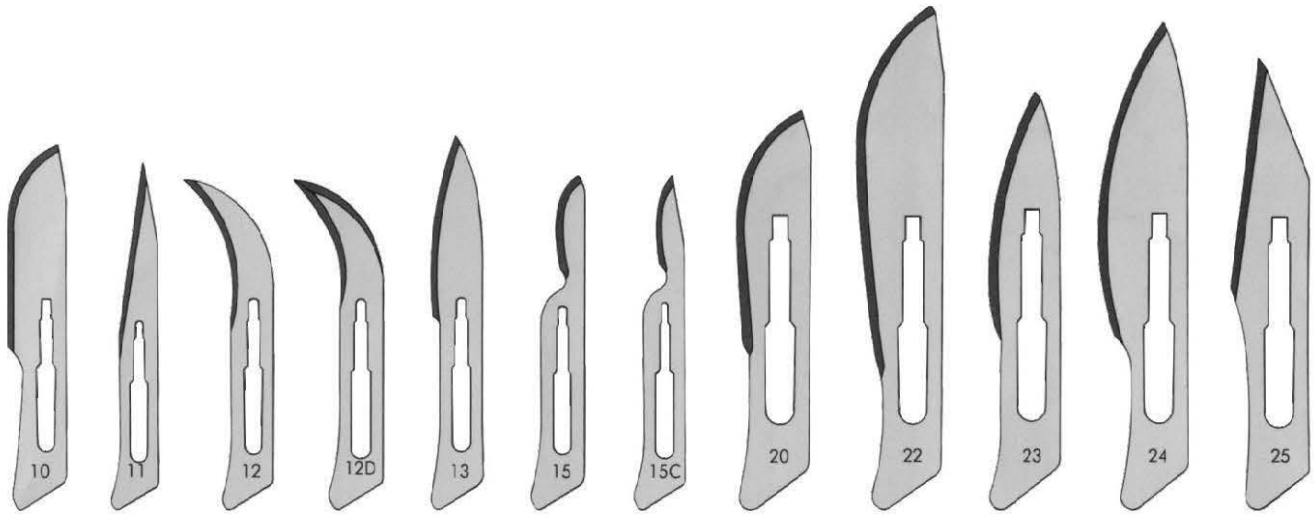


Fig. 3
TM-36-456

Fig. 3G
TM-36-457

Fig. 4
TM-36-458

Fig. 3L
TM-36-459

Fig. 7K
TM-36-460

Fig. 7
TM-36-461

TM-36-462
35 mm
TM-36-463
40 mm
TM-36-464
45 mm
TM-36-465
50 mm

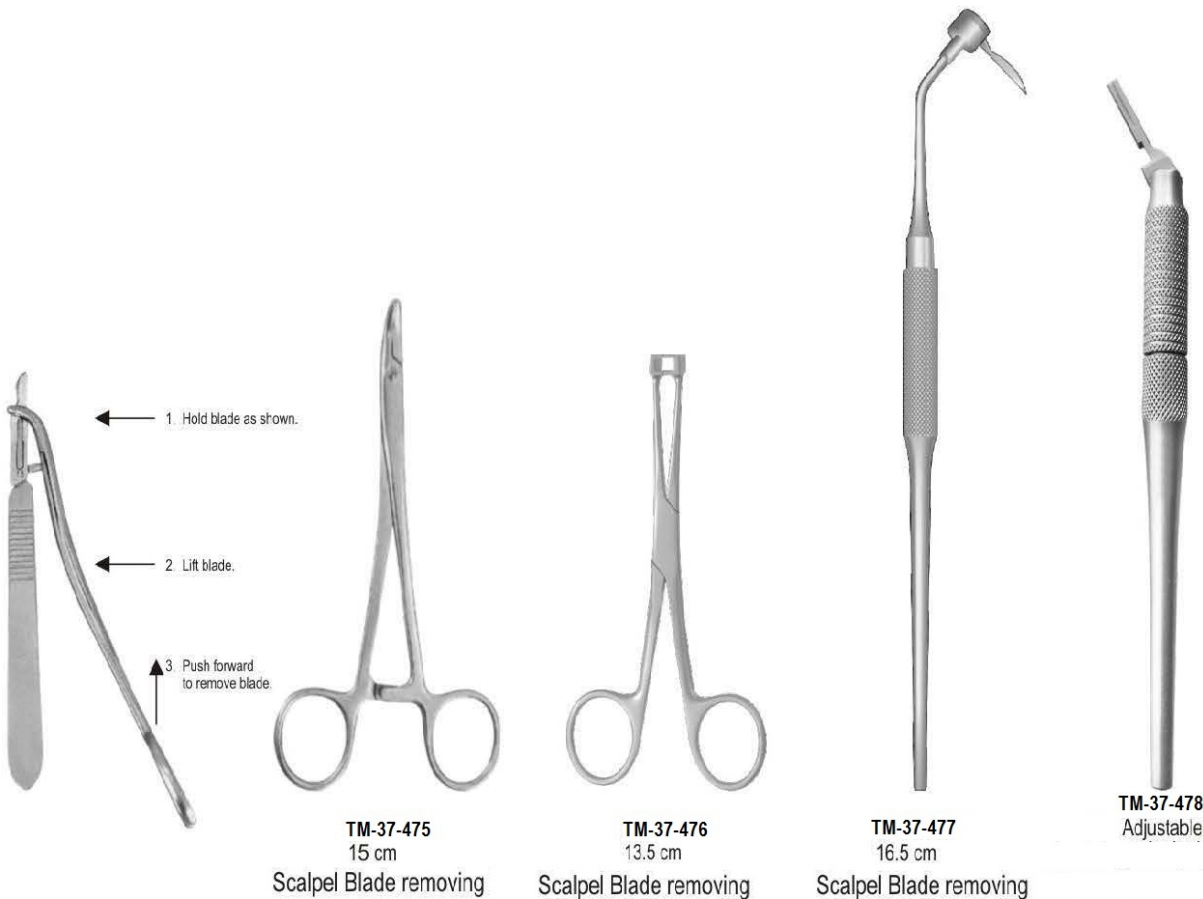
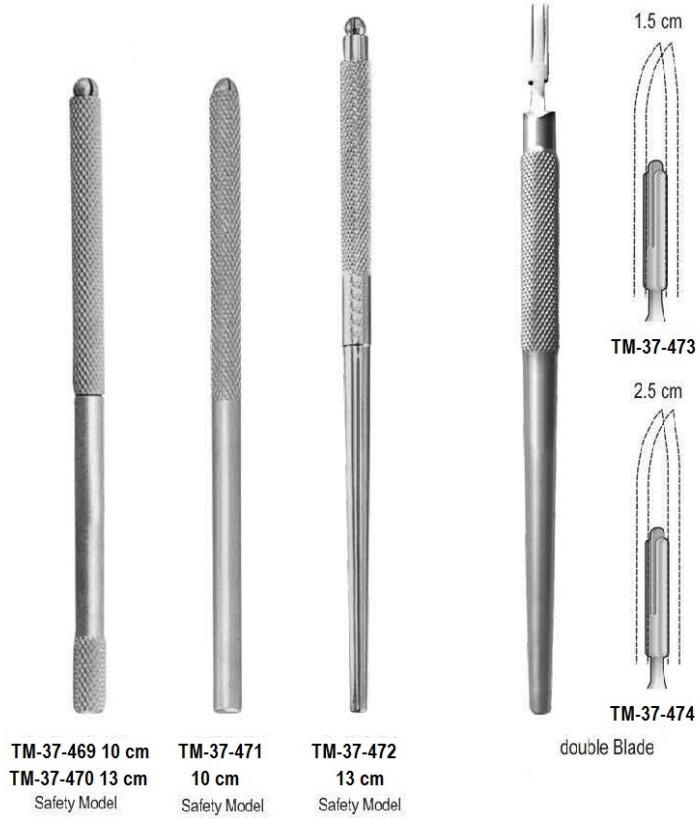
Fig. 5S
TM-36-466

Fig. 5A
TM-36-467

Fig. 5
TM-36-468



Scalpel Handle





Double Ended Rigid Hallow Handle



Fig. 23/17 TM-38-480



Fig. 23/17A TM-38-481

Double Ended Rigid Solid Handle

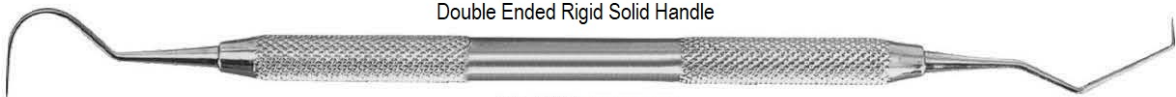


Fig. 23/17 TM-38-482



Fig. 23/17A TM-38-483



Fig. 23/16 TM-38-484

Double Ended Flexible Solid Handle



Fig. 2 TM-38-485



Fig. 3 TM-38-486



Fig. 5 TM-38-487

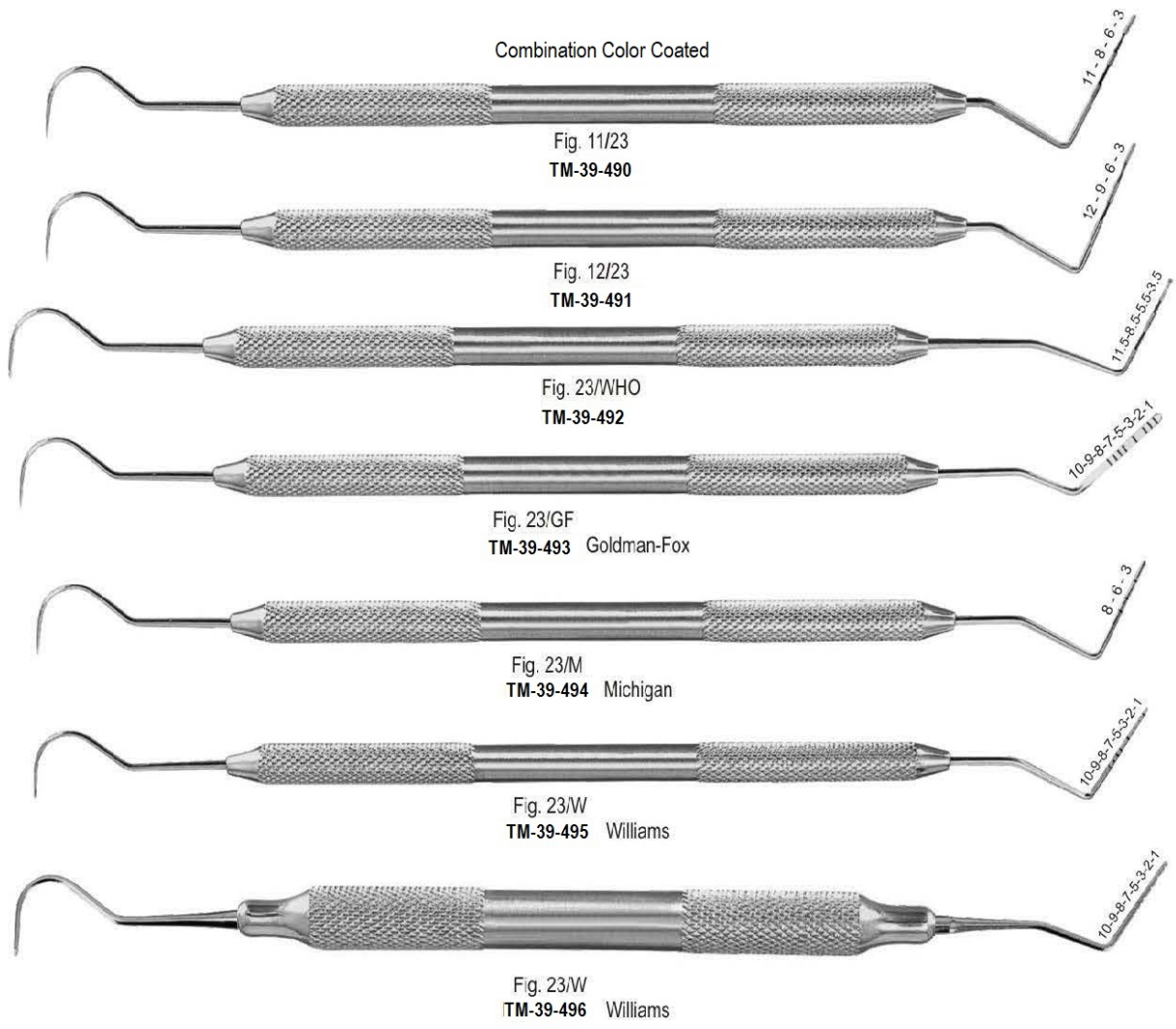


Fig. TU17/23 TM-38-488

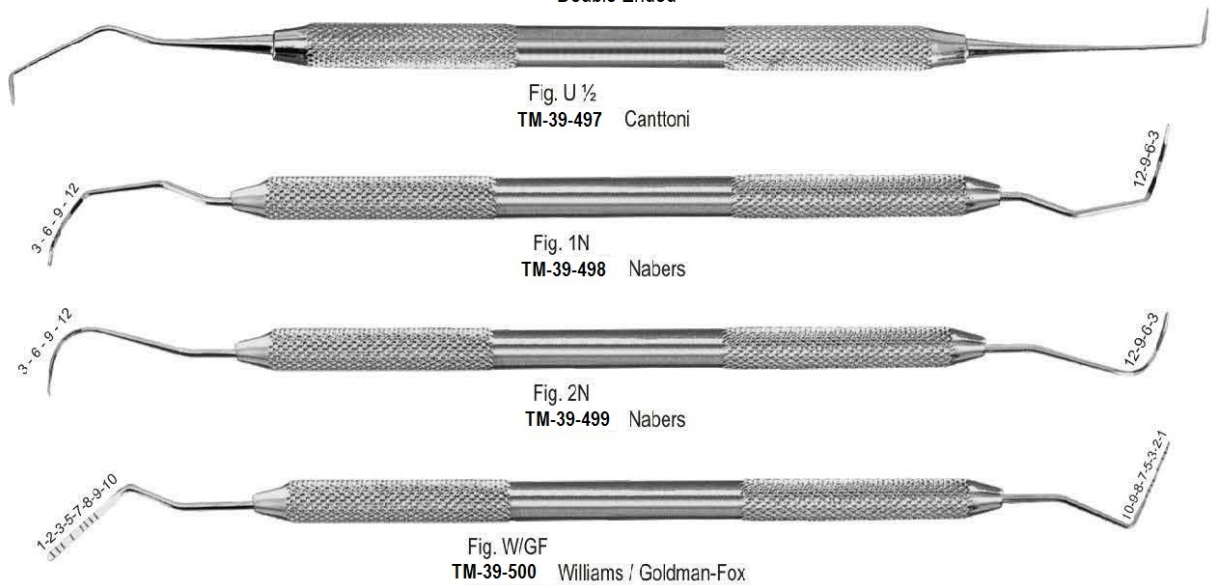


Fig. 6/23 TM-38-489

Combination Color Coated



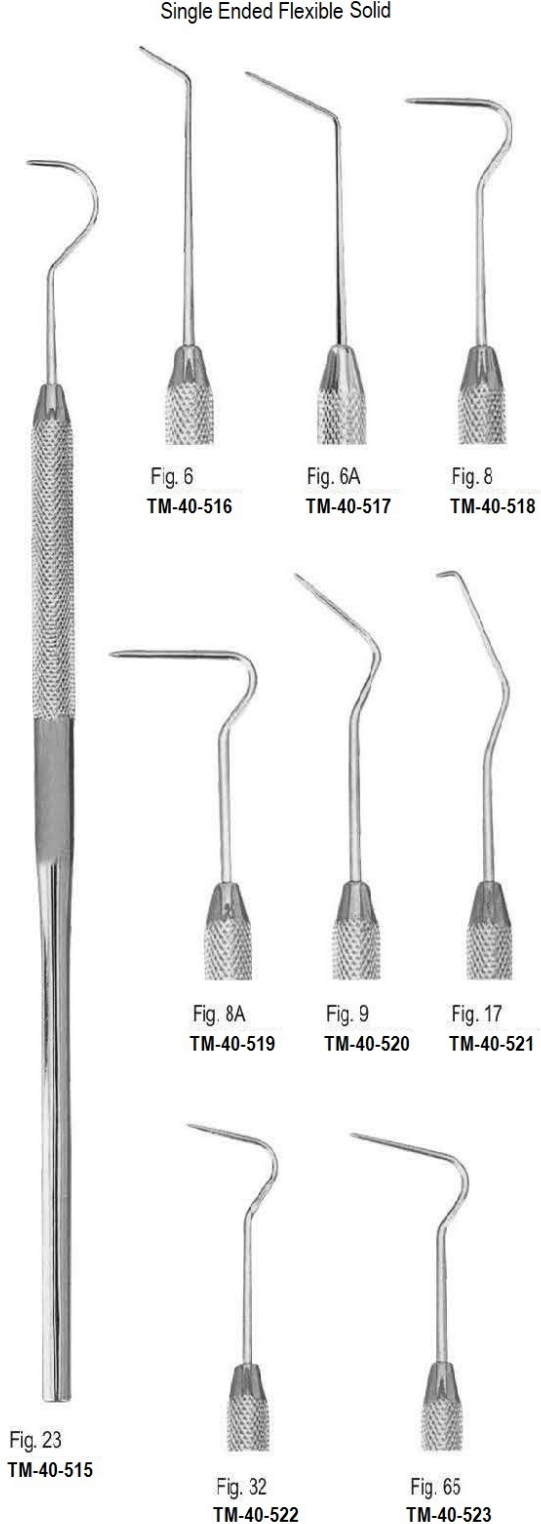
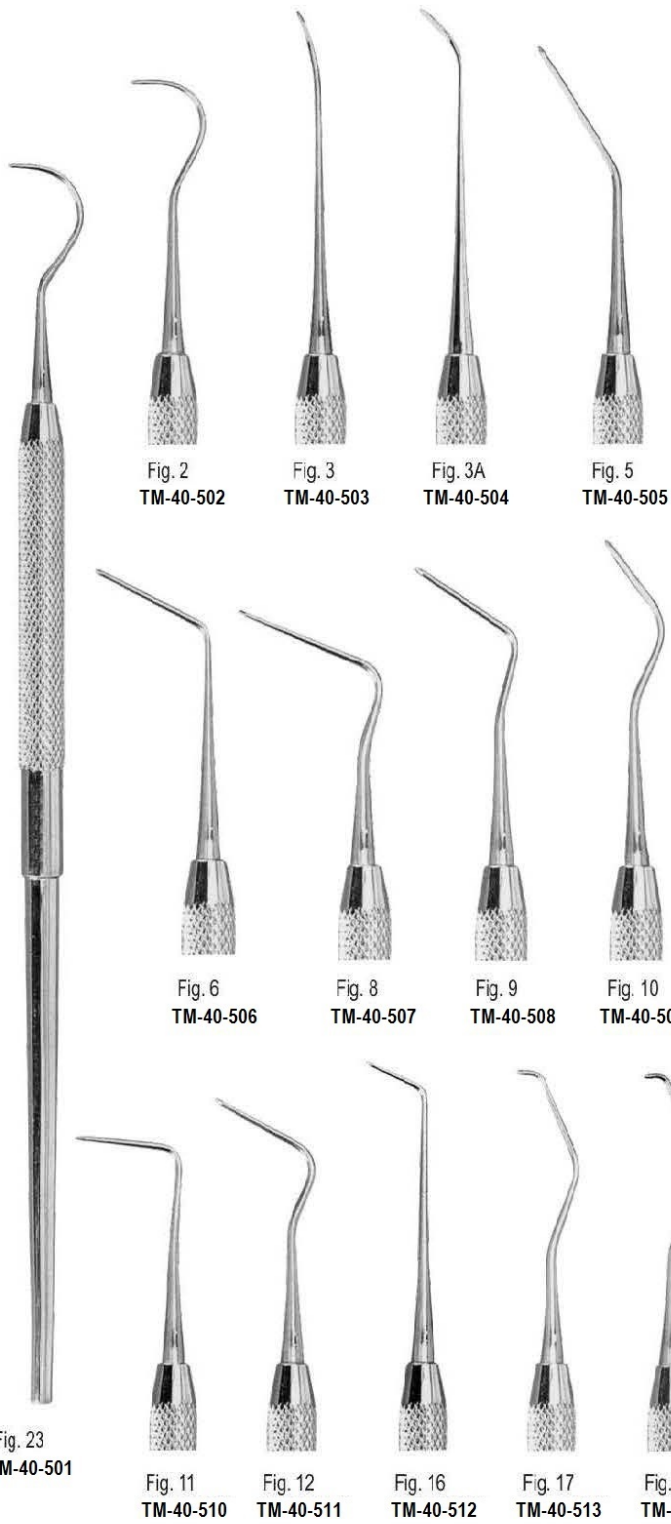
Double Ended





Single Ended Rigid Solid

Single Ended Flexible Solid



Single Ended Rigid Hollow

Single Ended Rigid Solid



Fig. 2
TM-41-524



Fig. 6
TM-41-525



Fig. 8
TM-41-526



Fig. 9
TM-41-527



Fig. 10
TM-41-528



Fig. 11
TM-41-529



Fig. 12
TM-41-530



Fig. 16
TM-41-531



Fig. 17
TM-41-532



Fig. 23
TM-41-533



Fig. 1
TM-41-534



Fig. 2
TM-41-535



Fig. 3
TM-41-536



Fig. 4
TM-41-537



Fig. 5
TM-41-538



Fig. 6
TM-41-539



Fig. 7
TM-41-540



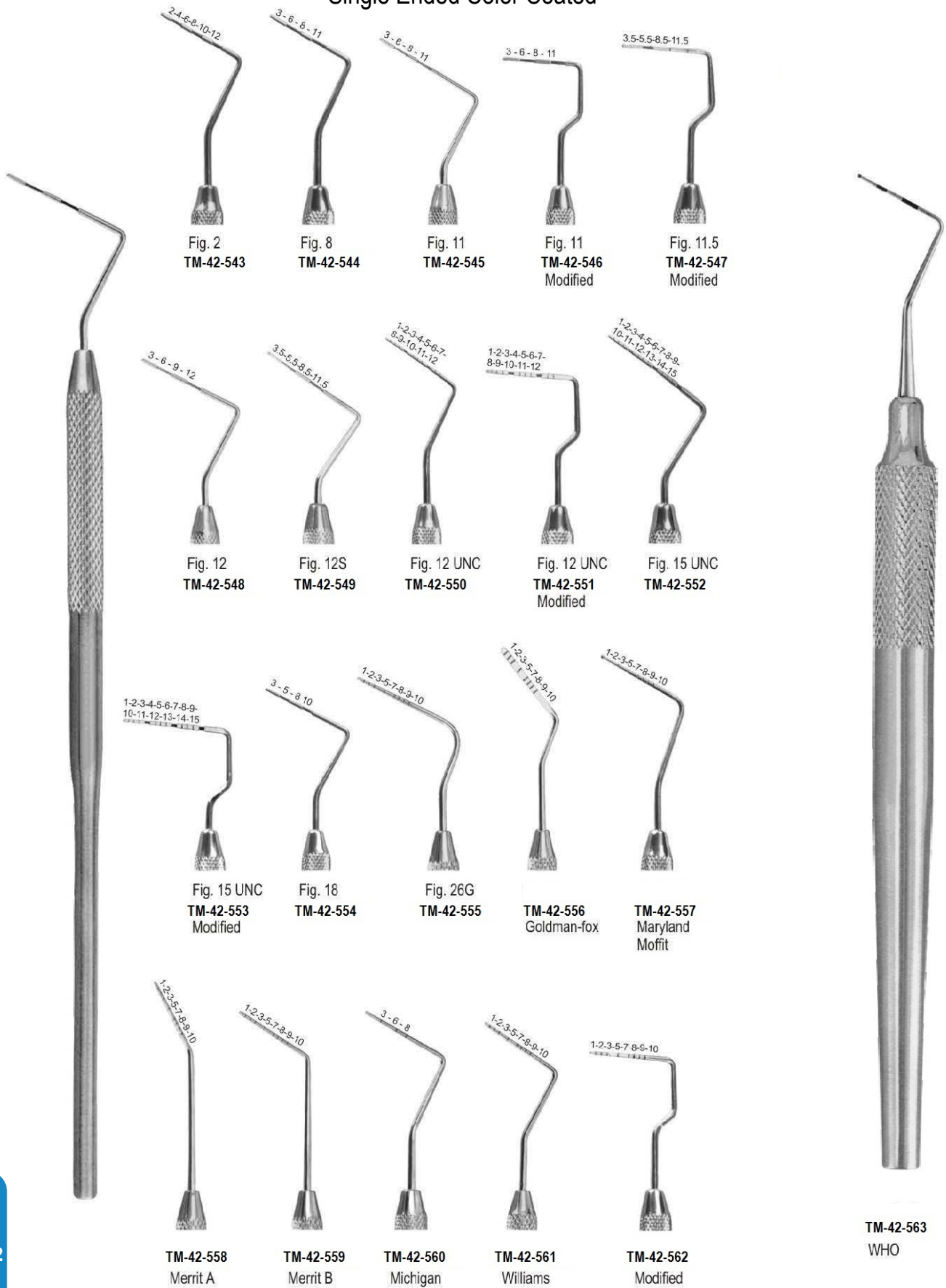
Fig. 8
TM-41-541



Fig. 9
TM-41-542



Single Ended Color Coated



Dental Probe

Endodontic


 Fig. 1
TM-43-564
 Brown

 Fig. DG 16
TM-43-565
 Stewart
 Yellow

Endodontic

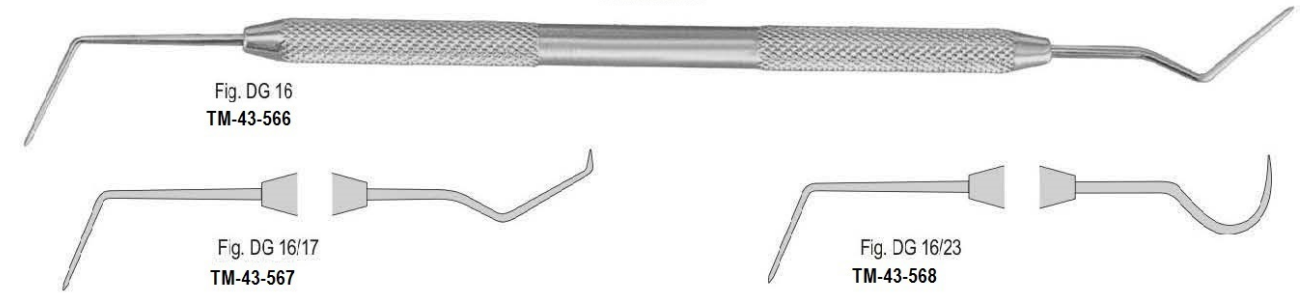

 Fig. DG 16
TM-43-566

 Fig. DG 16/17
TM-43-567

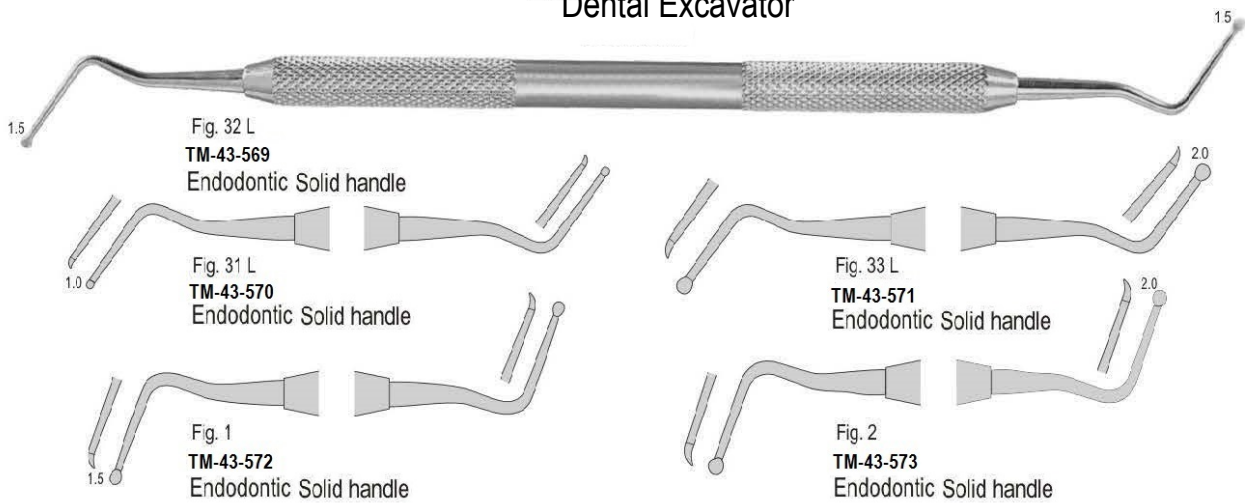
 Fig. DG 16/23
TM-43-568
Dental Excavator

 Fig. 32 L
TM-43-569
 Endodontic Solid handle

 Fig. 31 L
TM-43-570
 Endodontic Solid handle

 Fig. 1
TM-43-572
 Endodontic Solid handle

 Fig. 33 L
TM-43-571
 Endodontic Solid handle

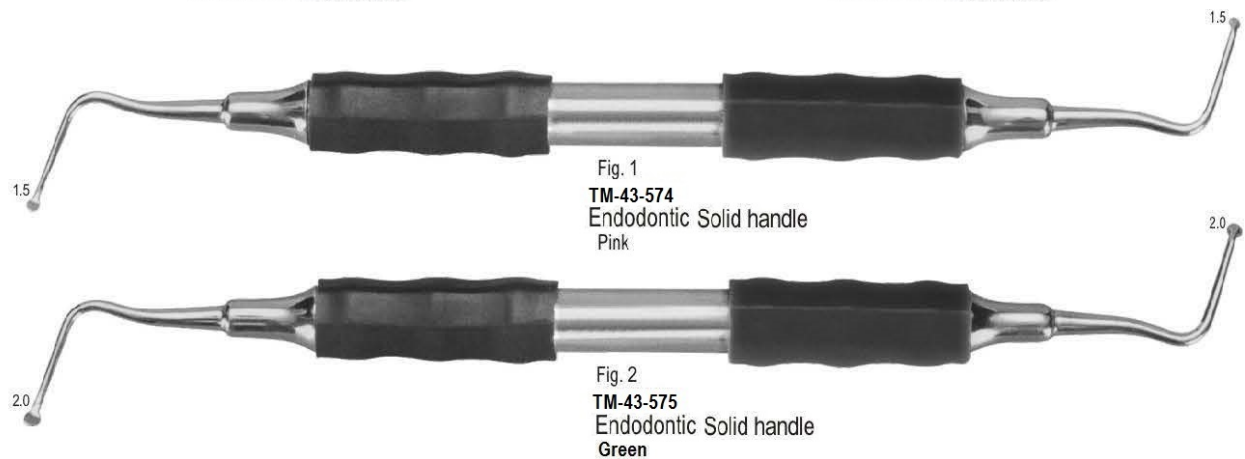
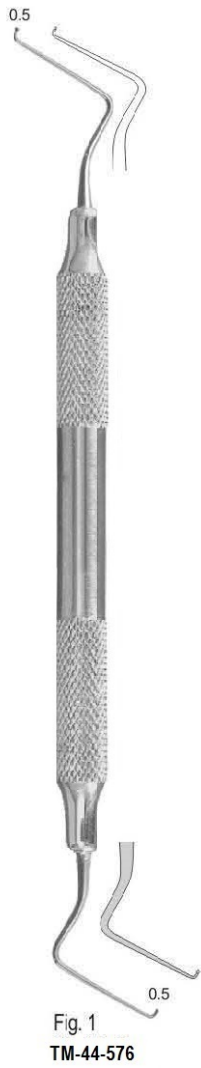
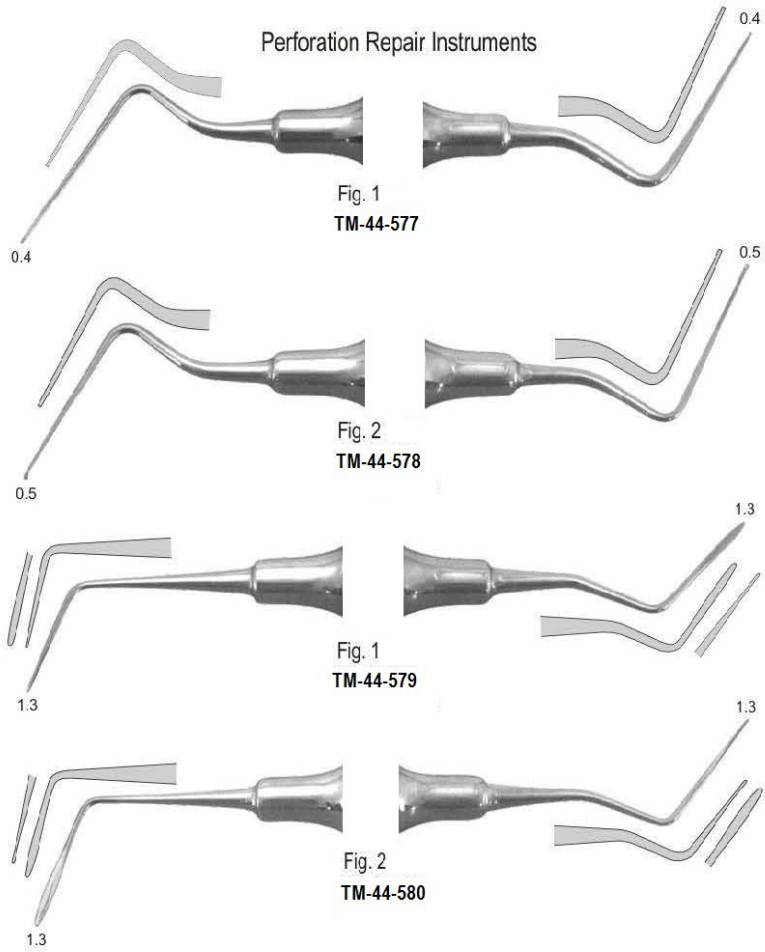
 Fig. 2
TM-43-573
 Endodontic Solid handle

 Fig. 1
TM-43-574
 Endodontic Solid handle
 Pink

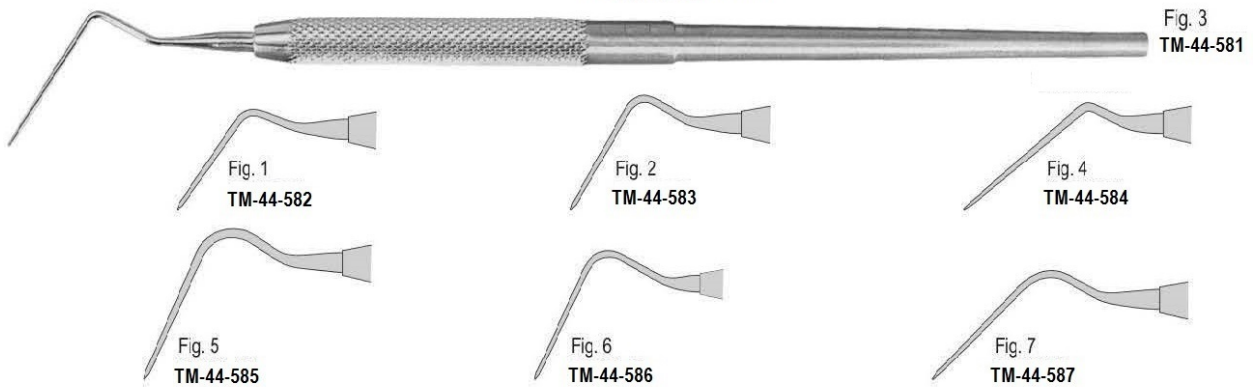
 Fig. 2
TM-43-575
 Endodontic Solid handle
 Green



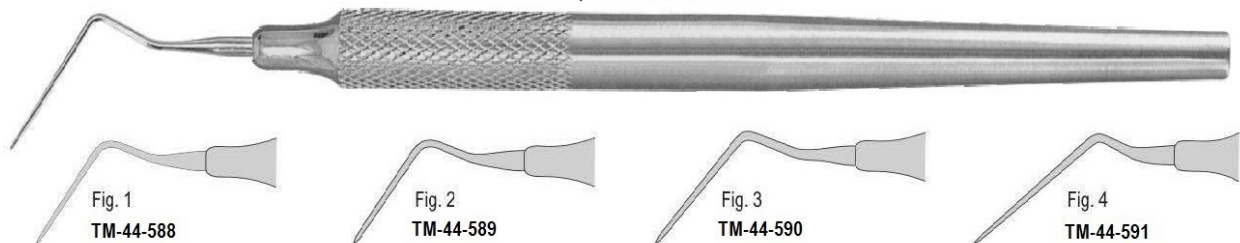
Perforation Repair Instruments



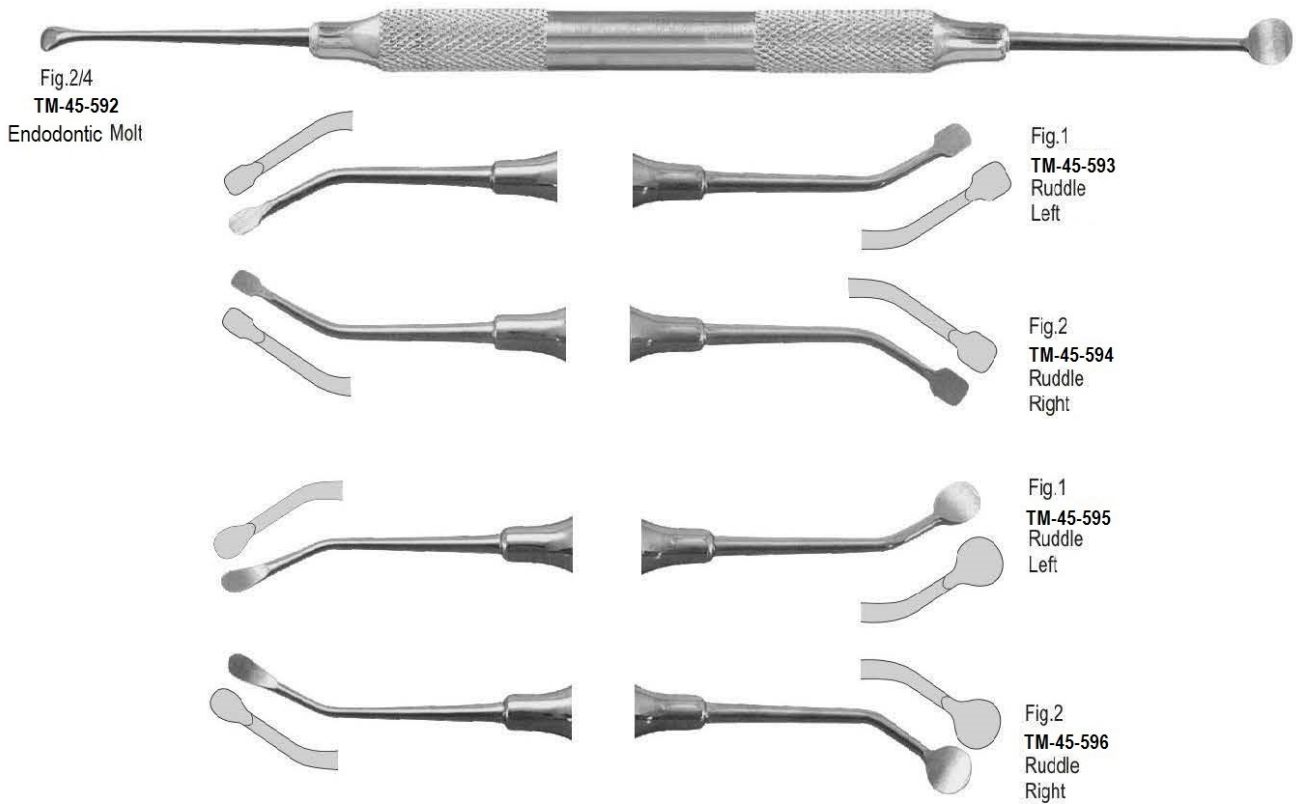
Spreaders Solid Handle



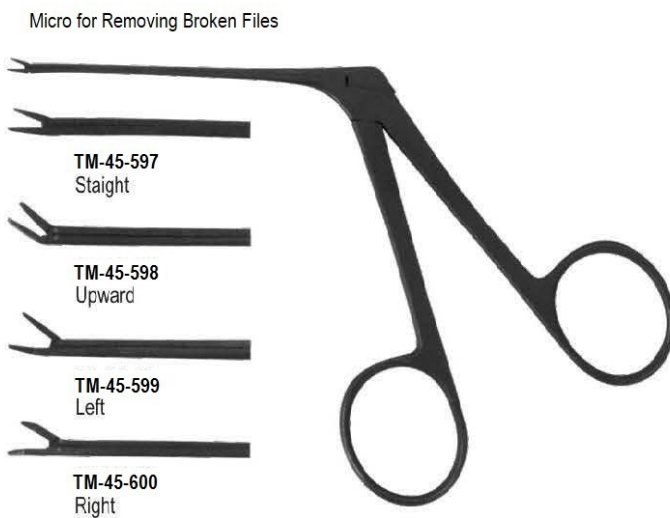
Spreaders Hollow Handle



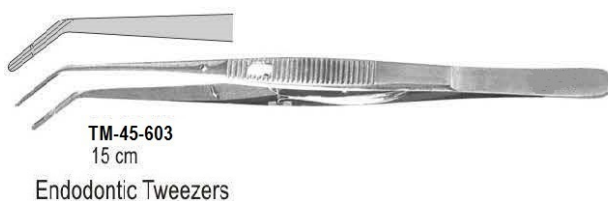
Peridontal Curette



Tissue Forceps Alligators



Dental Dressing Forceps

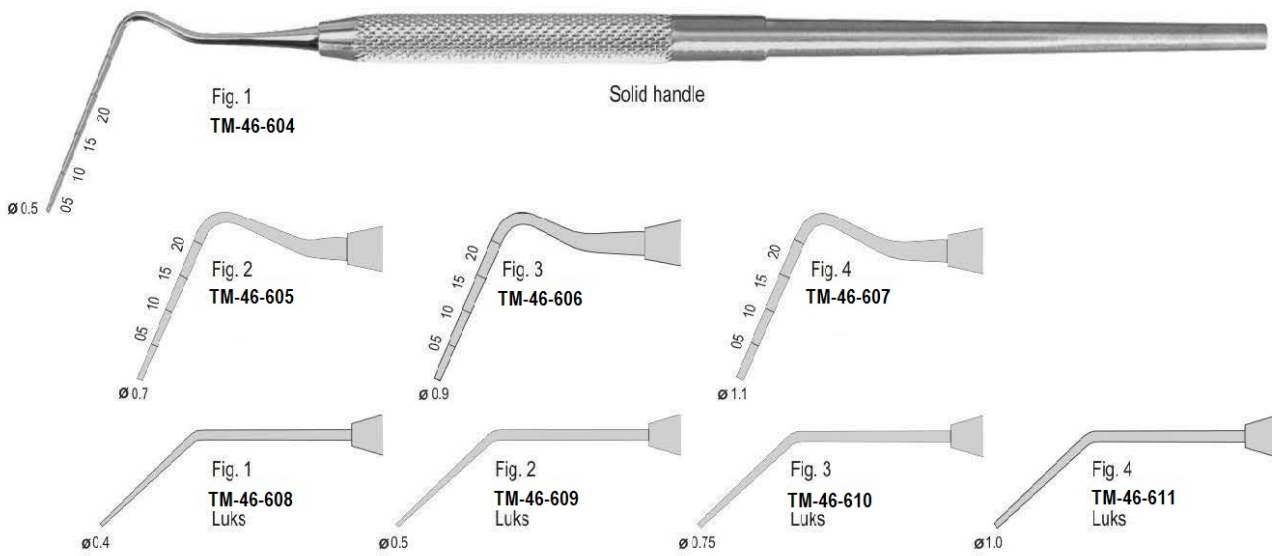


Tissue Forceps Scissors

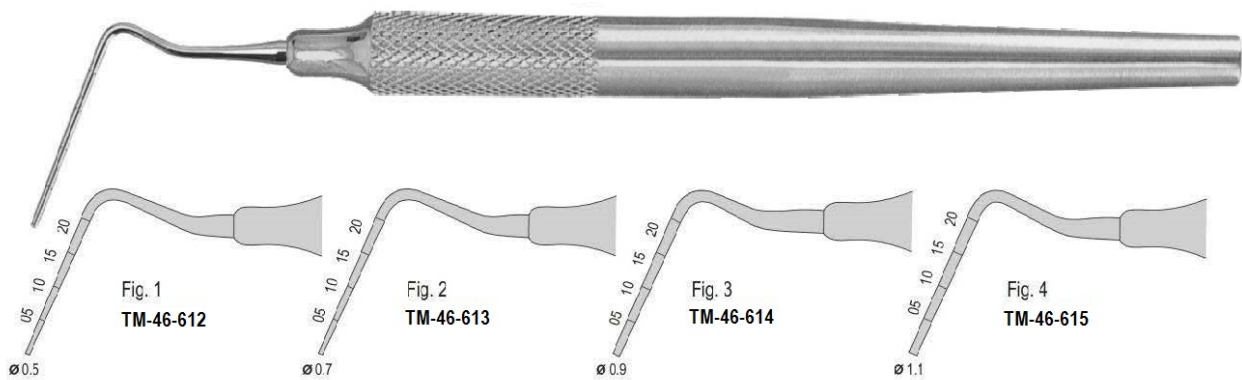


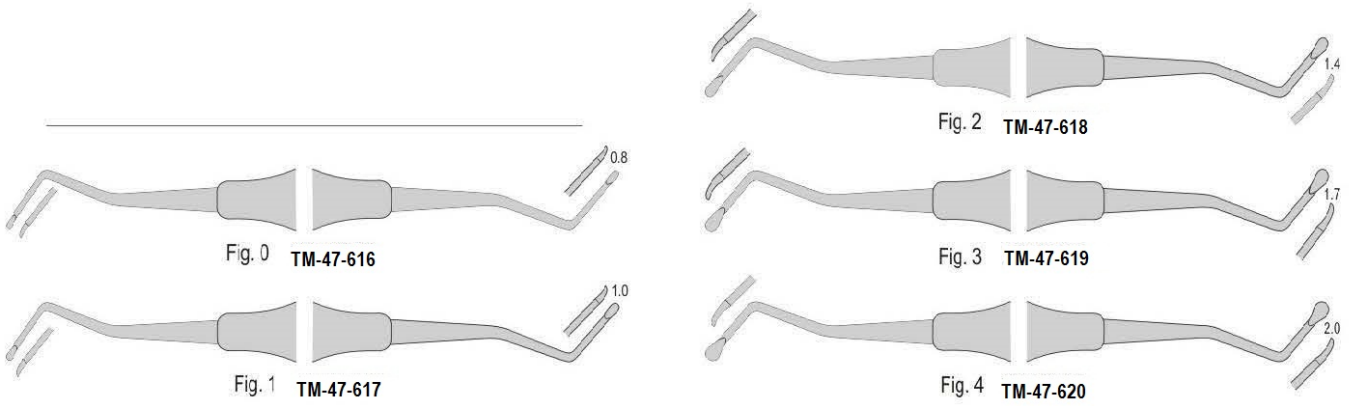
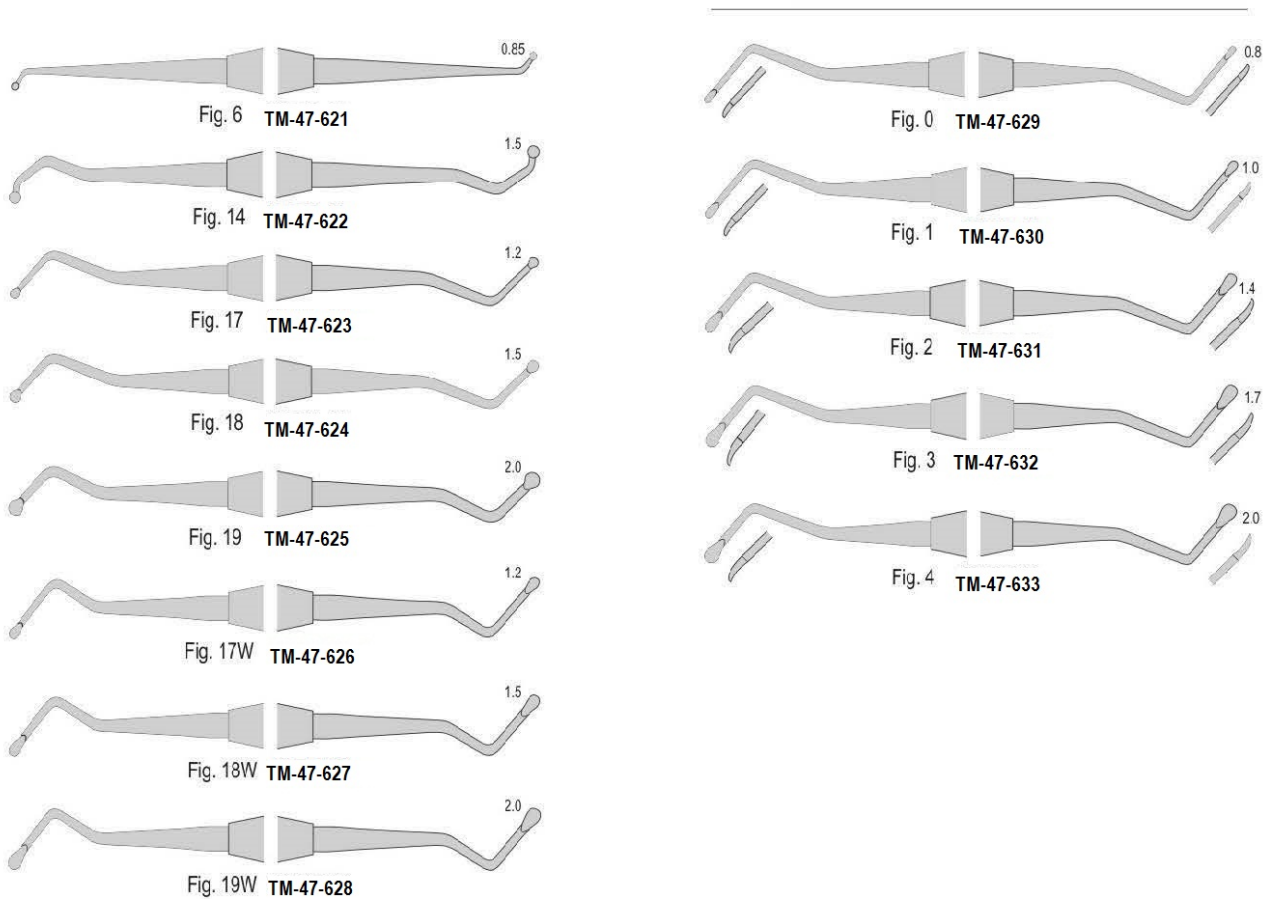


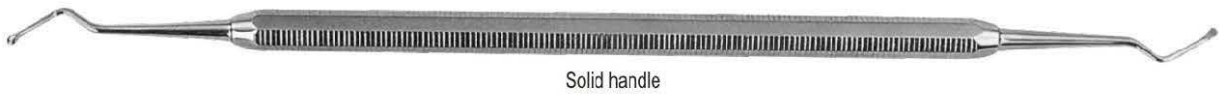
Plugger Solid Handle



Plugger Hollow handle



Hollow Handle

Solid handle




Solid handle

Palma

Type A

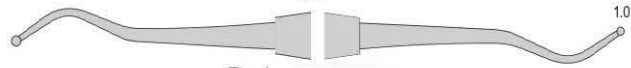


Fig. 1 **TM-48-634**

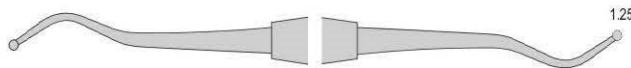


Fig. 2 **TM-48-635**

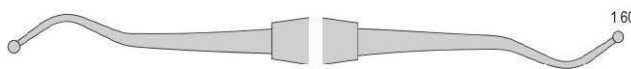


Fig. 3 **TM-48-636**

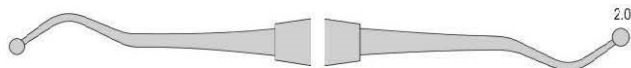


Fig. 4 **TM-48-637**

Type C

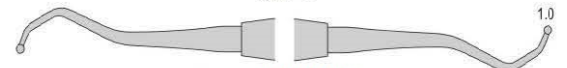


Fig. 1 **TM-48-638**

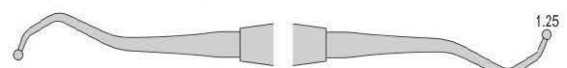


Fig. 2 **TM-48-639**

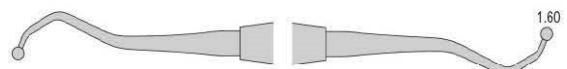


Fig. 3 **TM-48-640**

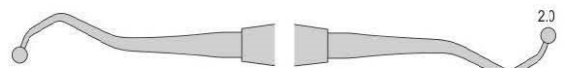
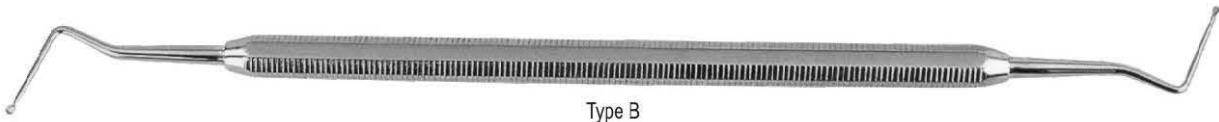


Fig. 4 **TM-48-641**



Type B

Palma



Fig. 1 **TM-48-642**

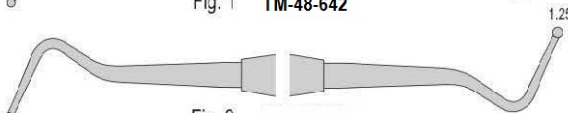


Fig. 2 **TM-48-643**

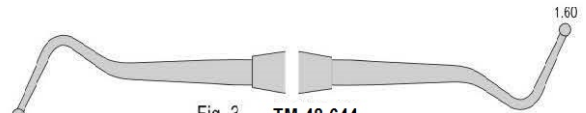


Fig. 3 **TM-48-644**

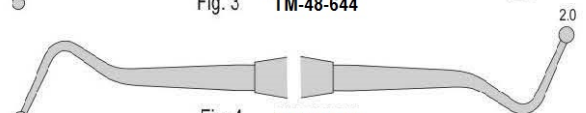
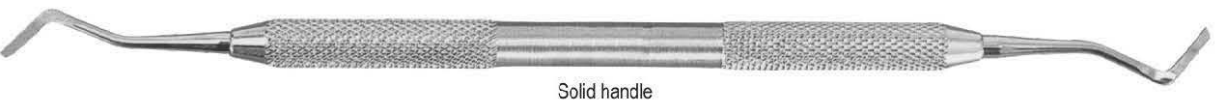


Fig. 4 **TM-48-645**



Solid handle

Blacks

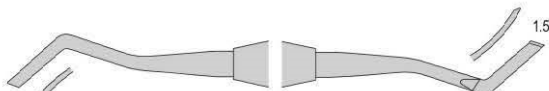


Fig. 77/78 **TM-48-646**

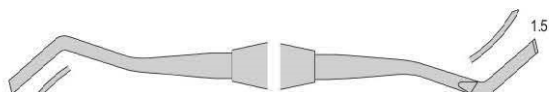


Fig. 79/80 **TM-48-647**

Ferrier

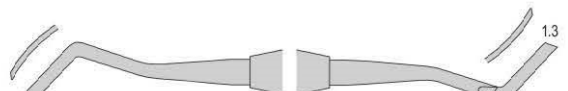


Fig. 26 **TM-48-648**

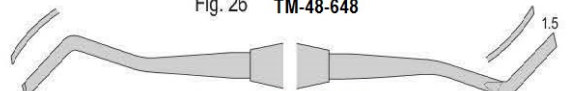


Fig. 27 **TM-48-649**

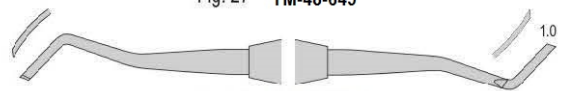


Fig. 28 **TM-48-650**

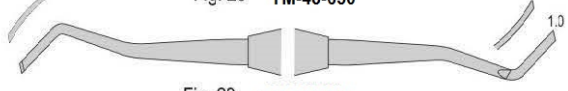


Fig. 29 **TM-48-651**

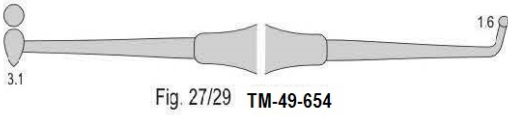
Burnisher Hollow Handle



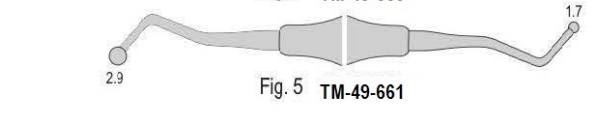
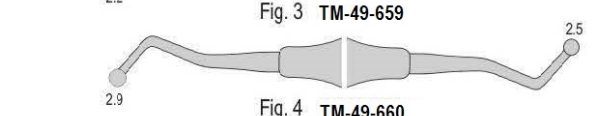
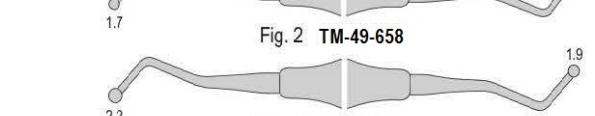
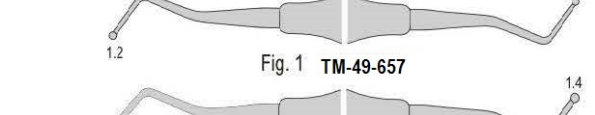
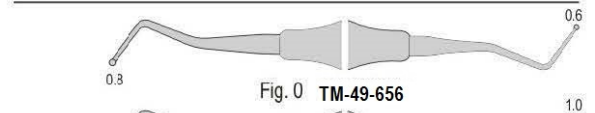
Acron / Wescott



White



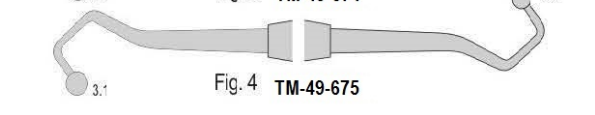
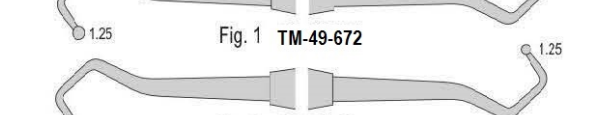
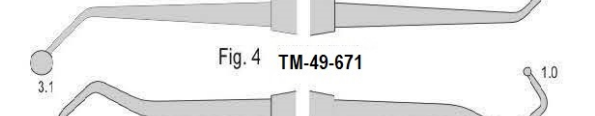
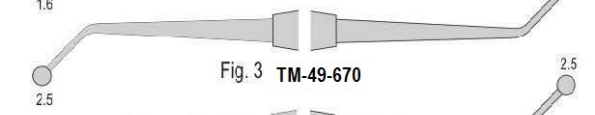
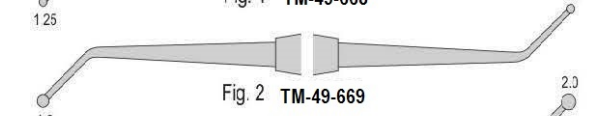
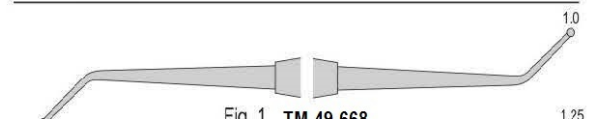
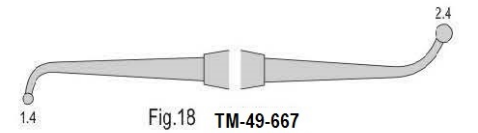
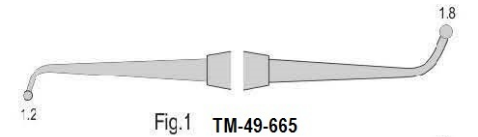
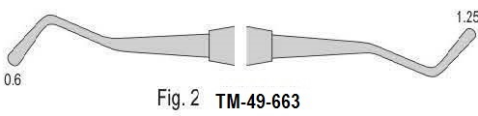
Freedman



Burnisher Solid Handle



Palma





Burnisher Solid Handle



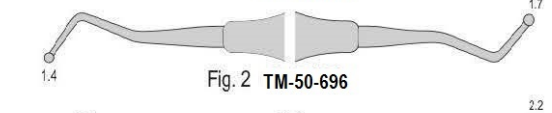
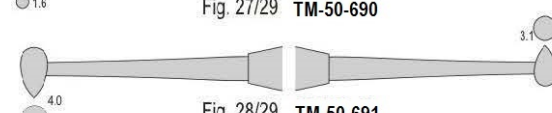
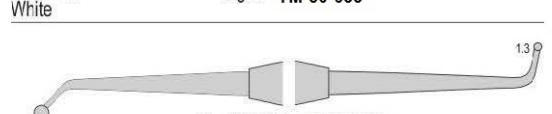
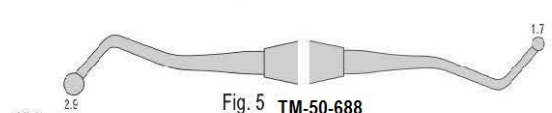
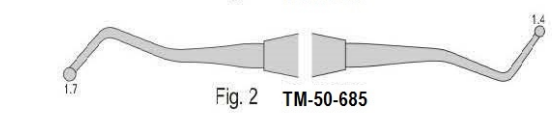
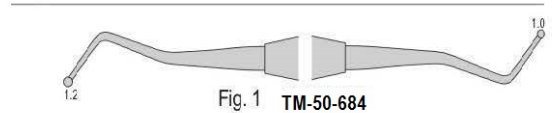
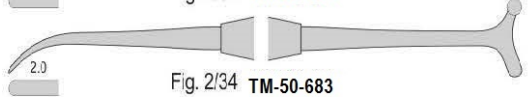
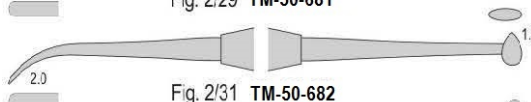
Acron / Wescott



Ladmore



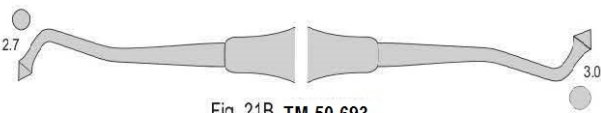
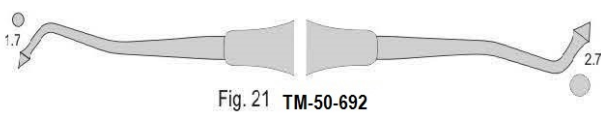
Beavertail / White



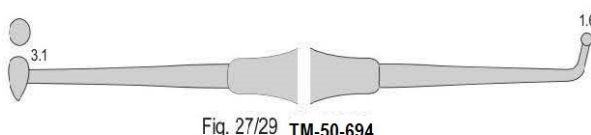
Burnisher Hollow Handle



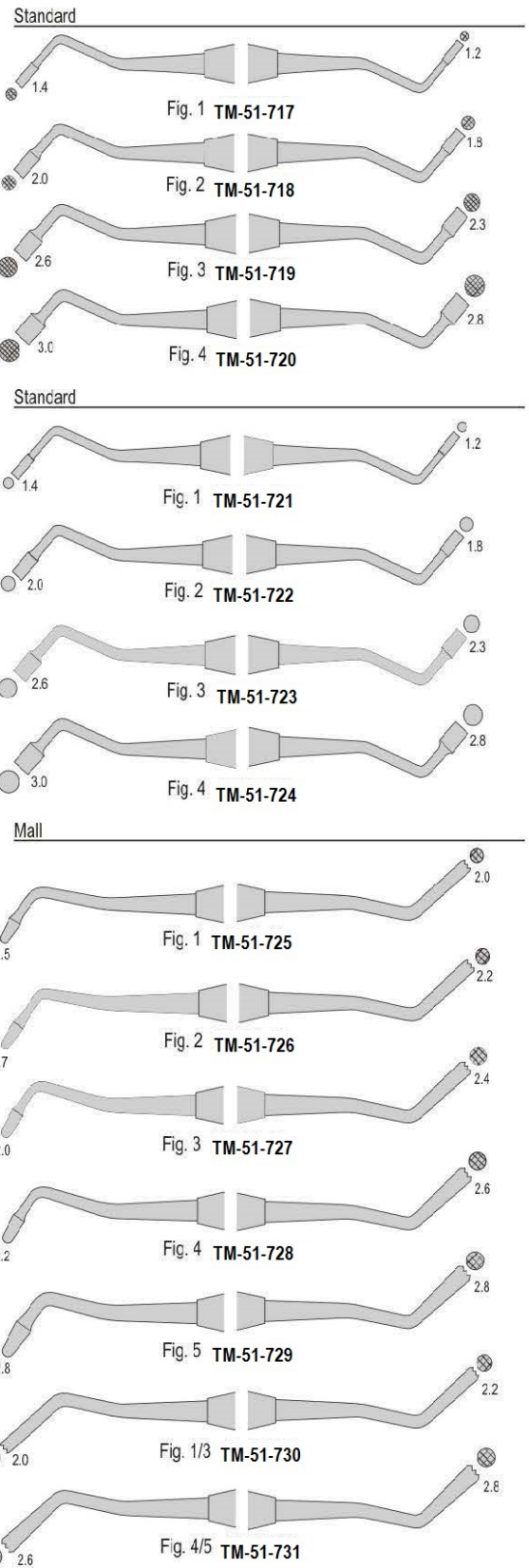
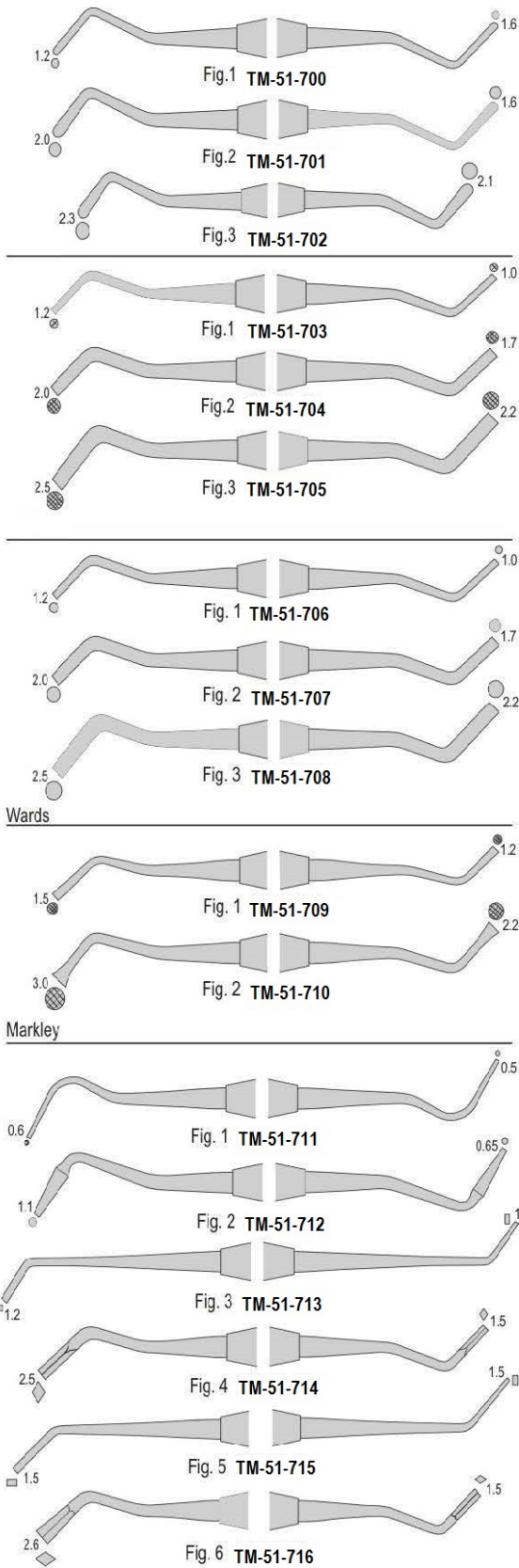
Acron / Wescott



White

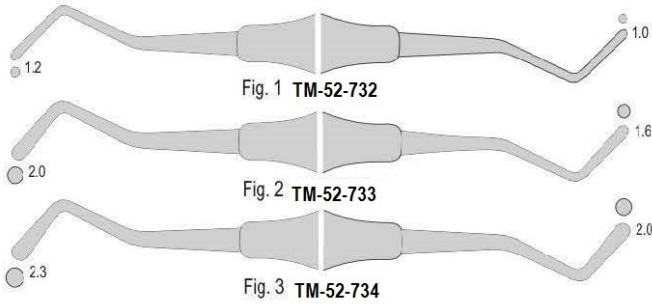


Amalgam Pluggers Solid Handle

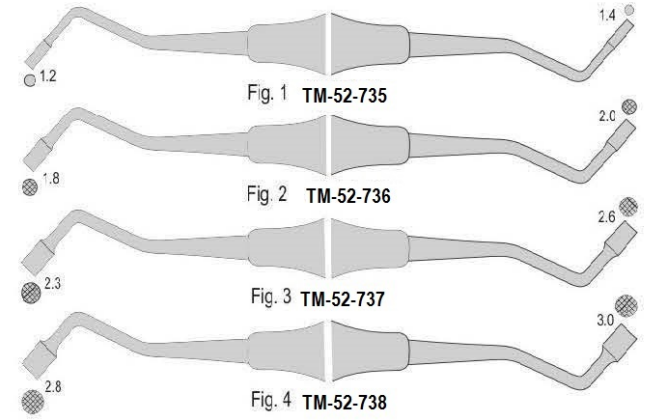
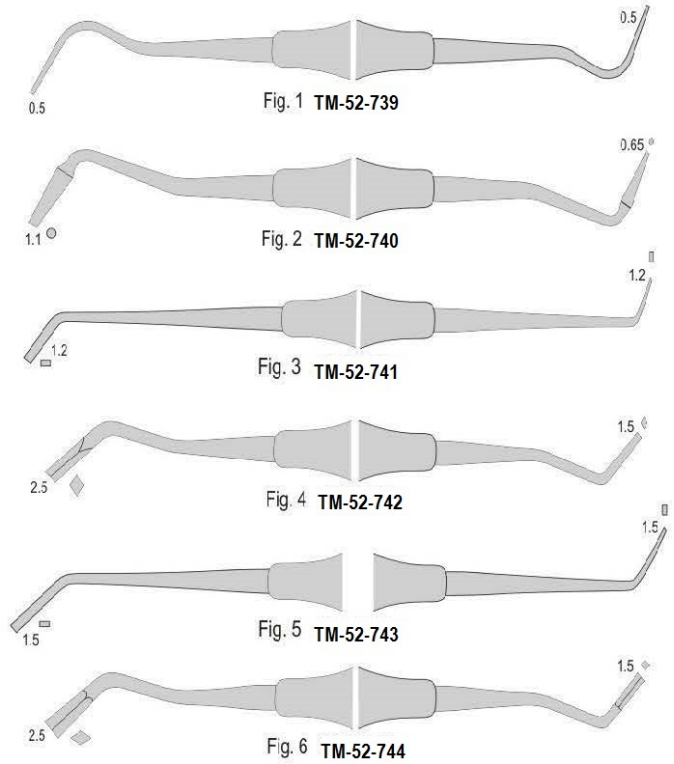




Amalgam Pluggers Hollow Handle



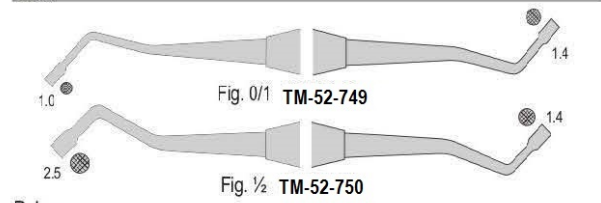
Markley



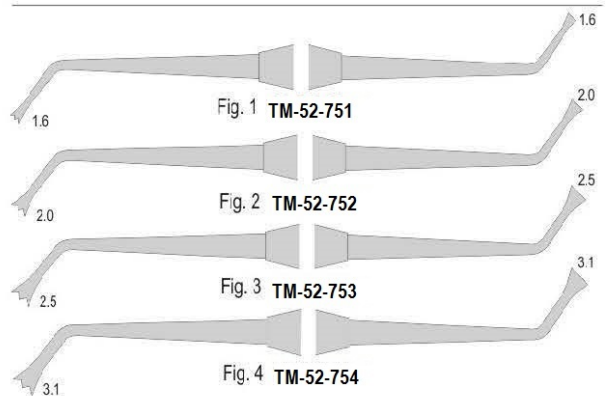
Amalgam Pluggers Solid Handle



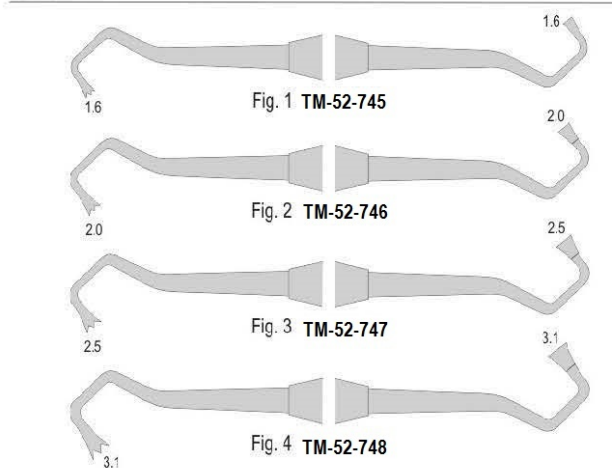
Black



Palma



Palma



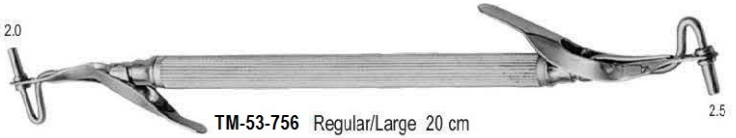
Dental Amalgam Carrier



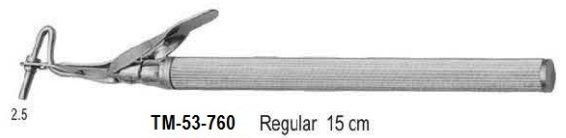
TM-53-755 Mini/Regular 20 cm



TM-53-759 Mini 15 cm



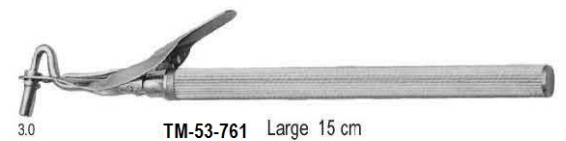
TM-53-756 Regular/Large 20 cm



TM-53-760 Regular 15 cm



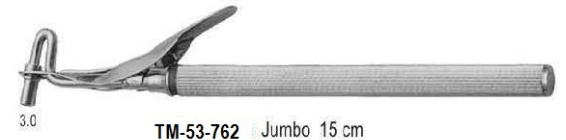
TM-53-757 Regular/Jumbo 20 cm



TM-53-761 Large 15 cm



TM-53-758 Large/Jumbo 20 cm



TM-53-762 Jumbo 15 cm



Fig. 10 **TM-53-763** 16.5 cm
English pattern



Fig. 1 **TM-53-766** Regular 15 cm



Fig. 1 **TM-53-764** 18.5 cm
German pattern



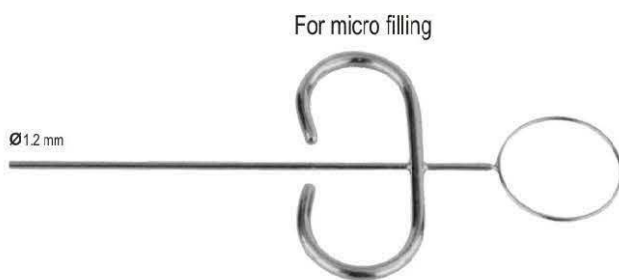
Fig. 2 **TM-53-767** Regular 15 cm



Fig. 1 **TM-53-765** 15 cm
Swiss pattern



Fig. 3 **TM-53-768** Regular 14 cm



TM-53-769
Straight
13 cm
TM-53-770
Curved
13 cm



Amalgam well

TM-53-771



Composite Instruments Titanium Coated



Pluggers



Fig. 5A TM-54-772



Fig. 3 TM-54-773 Hollenback



Fig. 1 TM-54-774 Super



Fig. OT TM-54-775 Tanner



Fig. 0/1 TM-54-776

Burnishers



Fig. 21B TM-54-778 Acom/Wescott



Fig. 1 TM-54-779 Contact Former



Fig. 2 TM-54-780 Contact Former



Fig. 2 TM-54-781 Ladmore



Fig. 3 TM-54-782 Ladmore



Fig. 27/29 TM-54-783



Fig. 1 TM-54-784



Fig. 1L TM-54-785



TM-54-777

Composite Filling Instrument Gold Titanium Coated Set of 6 pieces



TM-54-786

Composite Filling Instrument Blue Titanium Coated Set of 6 pieces

Composite Instruments Titanium Coated



Fig. 156(A6) **TM-55-787**



Fig. 8A **TM-55-788**



Fig. 1 **TM-55-789** Boghosian



Fig. 2 **TM-55-790** Boghosian



Fig. 1 **TM-55-791**



Fig. 2 **TM-55-792**



Fig. 1 **TM-55-793** Goldstein



Fig. 2 **TM-55-794** Goldstein



Fig. 3 **TM-55-795** Goldstein



Fig. 4 **TM-55-796** Goldstein



Fig. 1 **TM-55-797** Goldstein-Mini



Fig. 3 **TM-55-798** Goldstein-Mini



Fig. 4 **TM-55-799** Goldstein-Mini



Fig. 1 **TM-55-800** Goldstein-Micro



Fig. 4/5 **TM-55-801** Gregg



Fig. 0 **TM-55-802** Heidemann



Fig. 1 **TM-55-803** Heidemann



Fig. 2 **TM-55-804** Heidemann



Fig. W3 **TM-55-805**



Fig. 1 **TM-55-806**



Fig. 6 **TM-55-807**



Fig. 178 **TM-55-808**



Fig. 49 **TM-55-809**



Fig. 179 **TM-55-810**



Plastic Filling Instruments Solid Handle



Fig. 6 TM-56-811

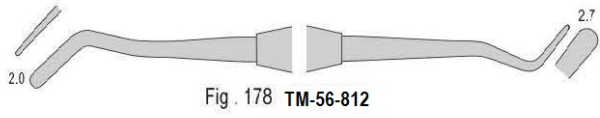


Fig. 178 TM-56-812

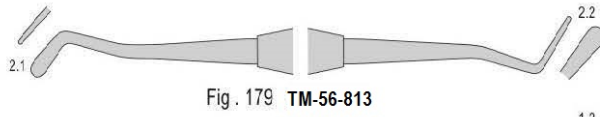


Fig. 179 TM-56-813

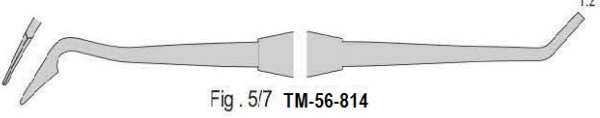


Fig. 5/7 TM-56-814

Gregg

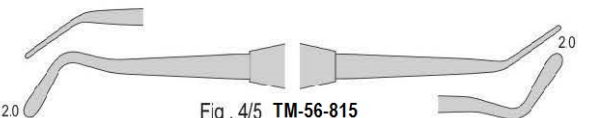


Fig. 4/5 TM-56-815

Woodson

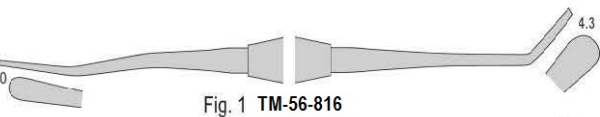


Fig. 1 TM-56-816

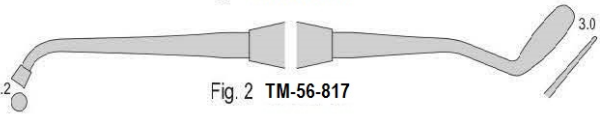


Fig. 2 TM-56-817



Fig. 3 TM-56-818

Heidemann



Fig. 0 TM-56-819

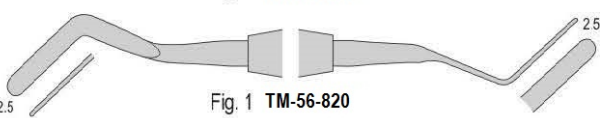


Fig. 1 TM-56-820

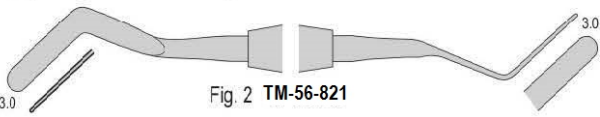


Fig. 2 TM-56-821



Fig. 0 TM-56-822

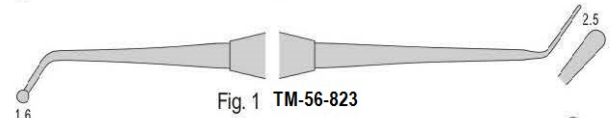


Fig. 1 TM-56-823



Fig. 2 TM-56-824



Fig. 3 TM-56-825



Fig. 4 TM-56-826



Fig. 5 TM-56-827



Fig. 6 TM-56-828

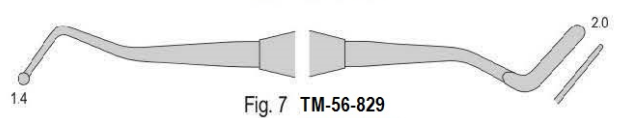


Fig. 7 TM-56-829



Fig. 8 TM-56-830



Fig. 9 TM-56-831

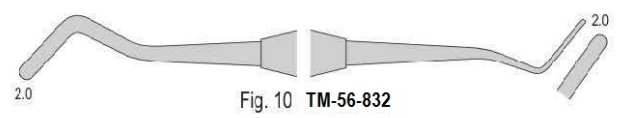


Fig. 10 TM-56-832

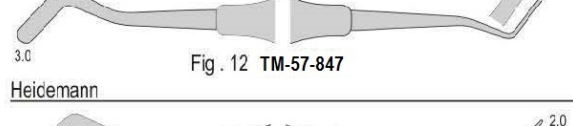
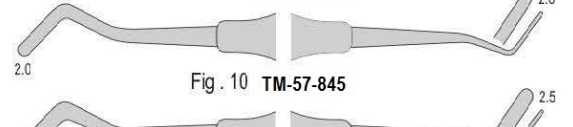
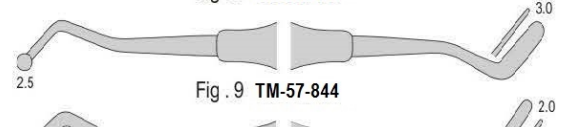
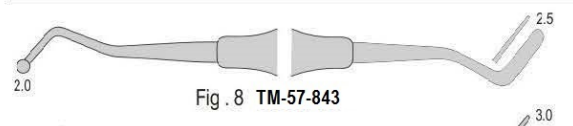
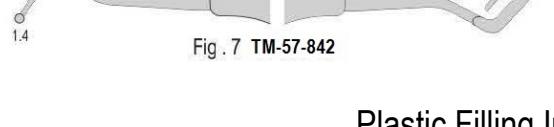
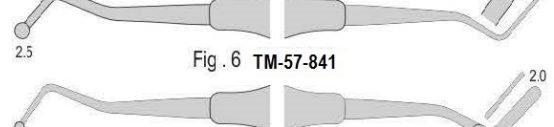
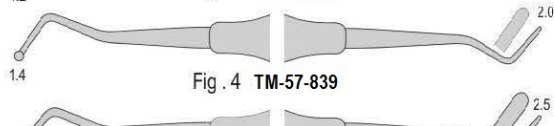
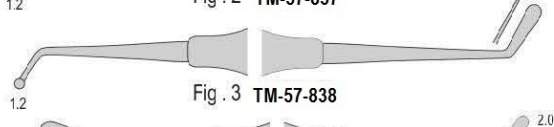
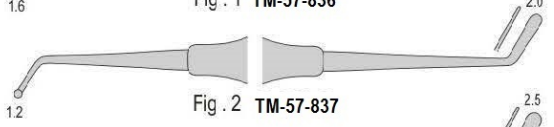
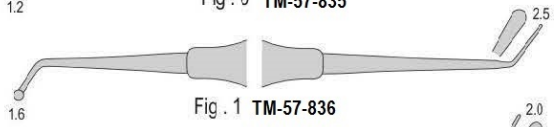


Fig. 11 TM-56-833

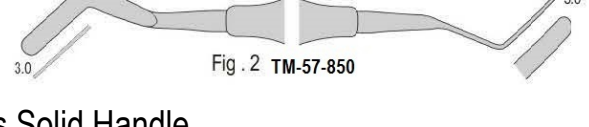
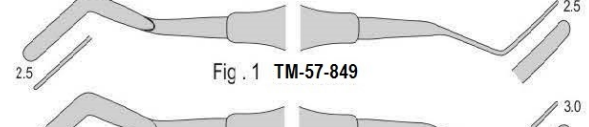
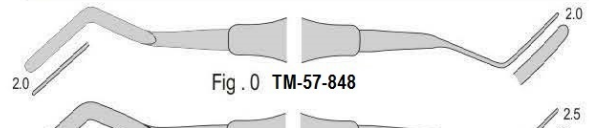


Fig. 12 TM-56-834

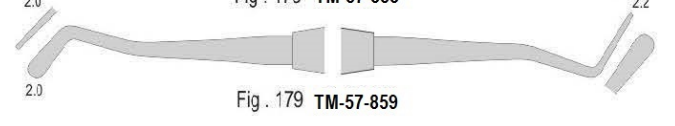
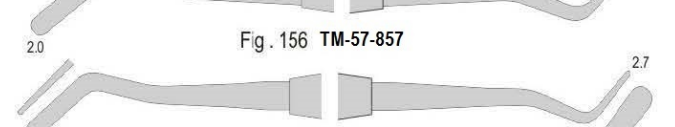
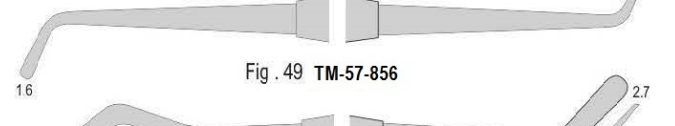
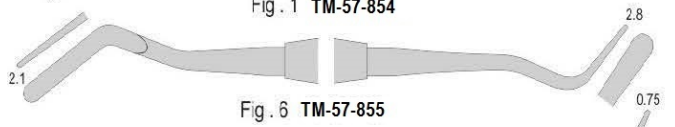
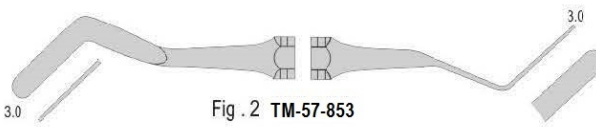
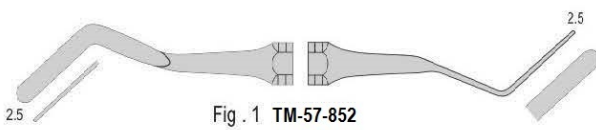
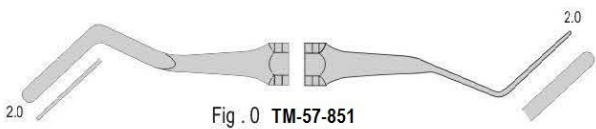
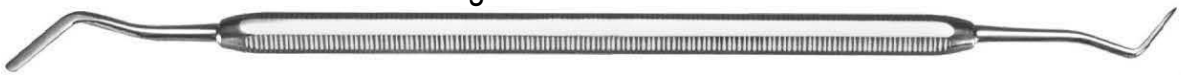
Plastic Filling Instruments Hollow Handle



Heidemann

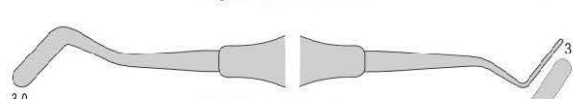
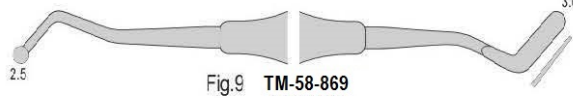
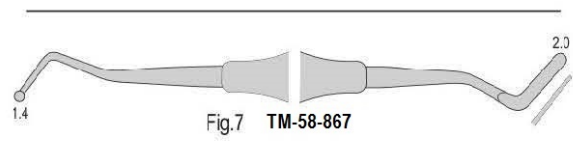
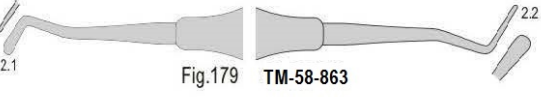
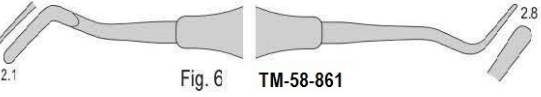
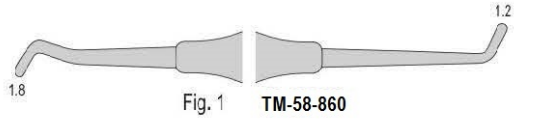


Plastic Filling Instruments Solid Handle

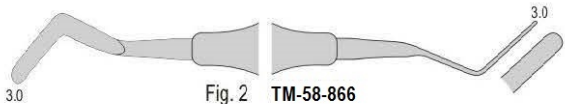
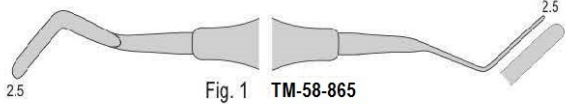
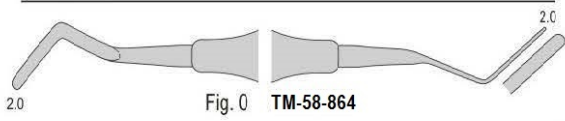




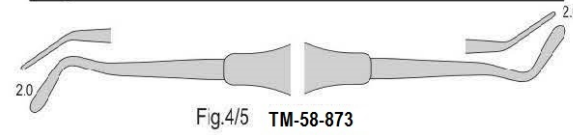
Plastic Filling Instruments Hollow Handle



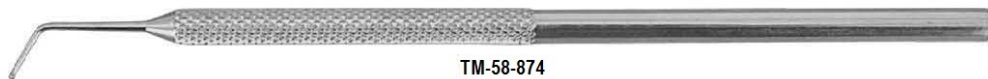
Heidemann



Gregg



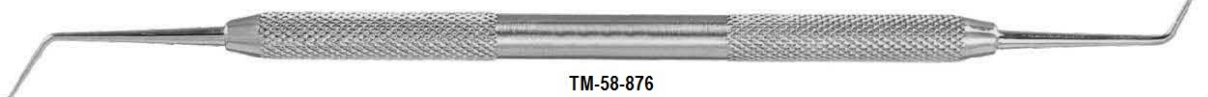
Applicators for calcium hydroxide



TM-58-874



TM-58-875



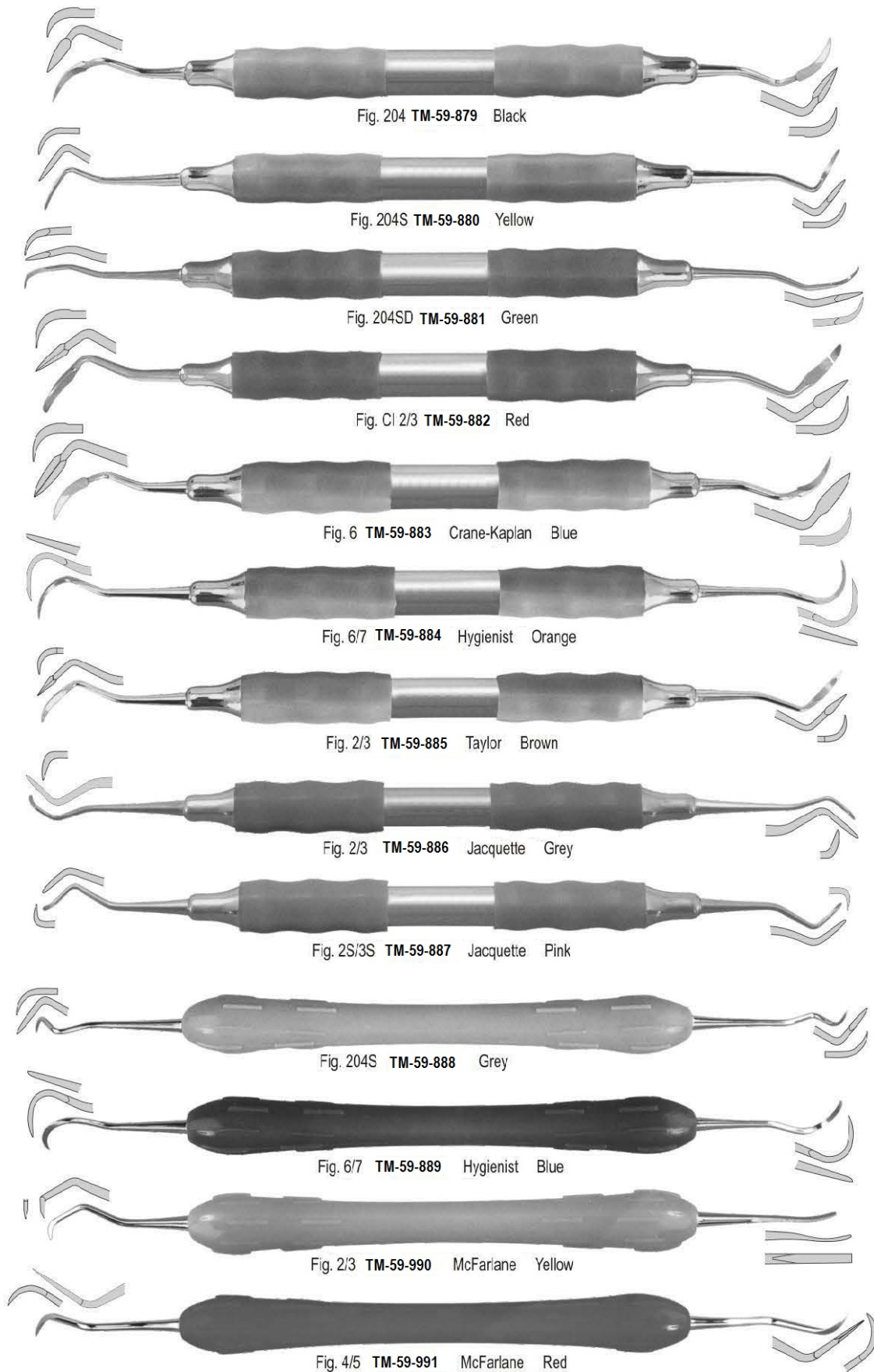
TM-58-876



TM-58-877



TM-58-878
Morris set of 7 pieces





Solid Handle

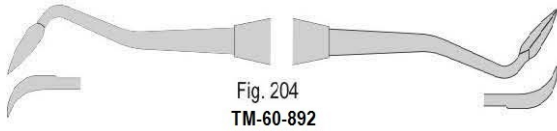


Fig. 204
TM-60-892

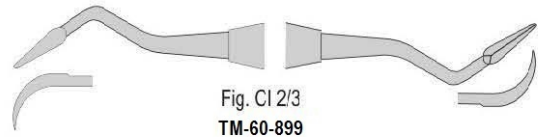


Fig. CI 2/3
TM-60-899

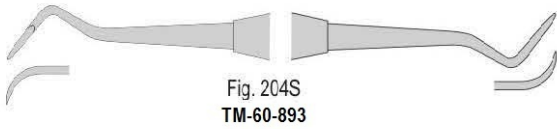


Fig. 204S
TM-60-893

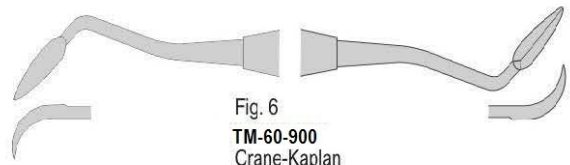


Fig. 6
TM-60-900
Crane-Kaplan

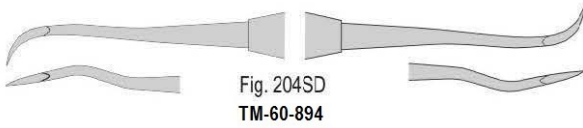


Fig. 204SD
TM-60-894

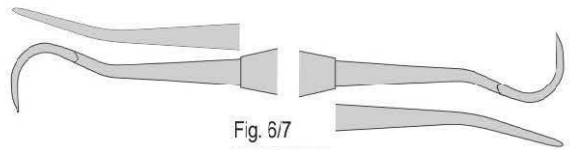


Fig. 6/7
TM-60-901
Hygienist

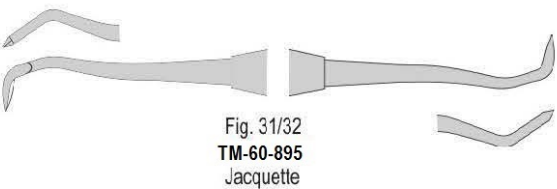


Fig. 31/32
TM-60-895
Jacquette

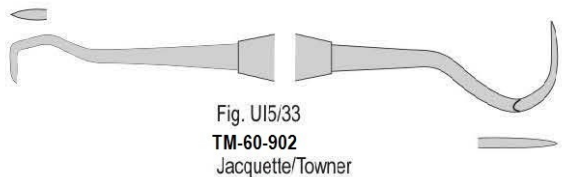


Fig. UI5/33
TM-60-902
Jacquette/Towner

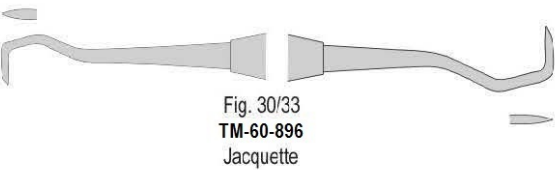


Fig. 30/33
TM-60-896
Jacquette

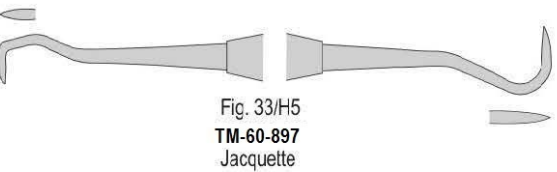


Fig. 33/H5
TM-60-897
Jacquette

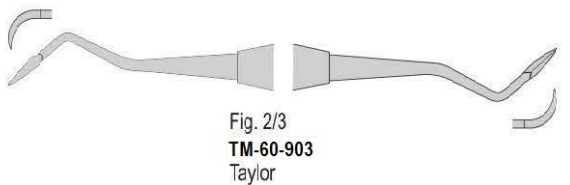


Fig. 2/3
TM-60-903
Taylor

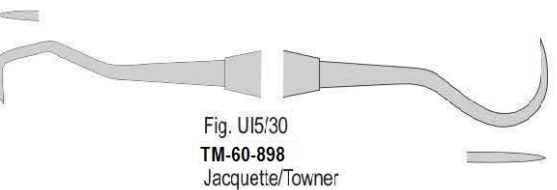


Fig. UI5/30
TM-60-898
Jacquette/Towner

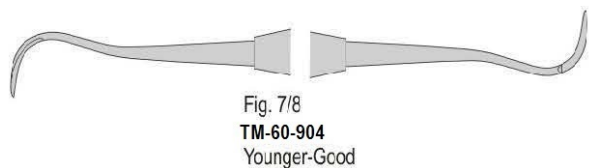
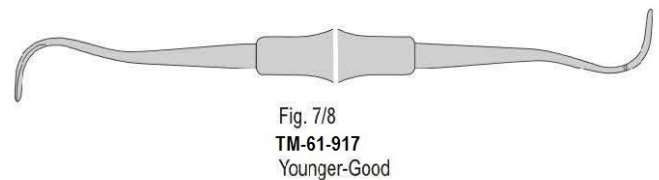
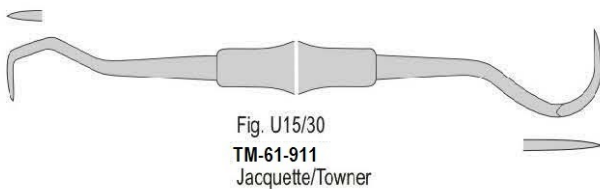
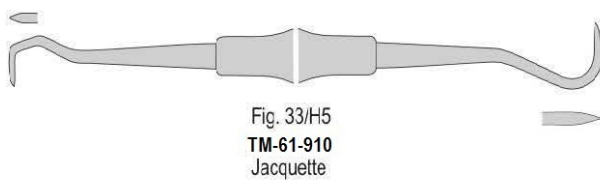
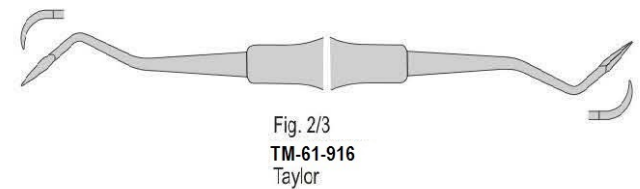
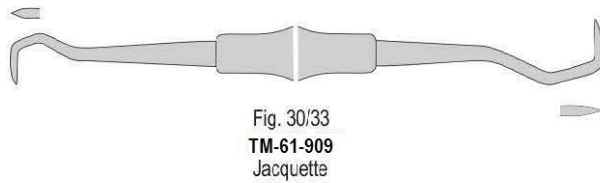
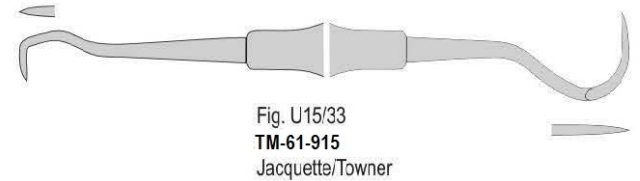
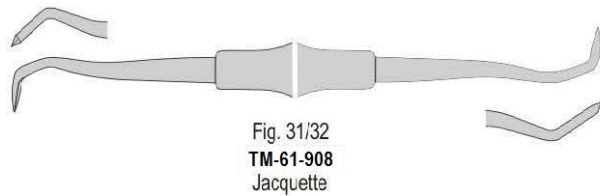
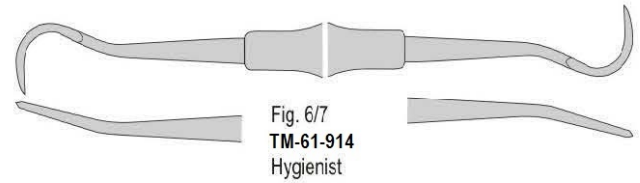
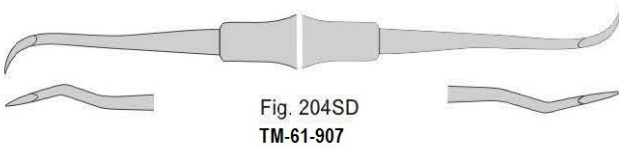
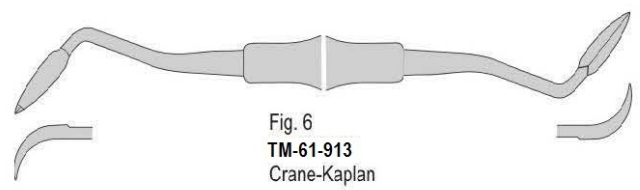
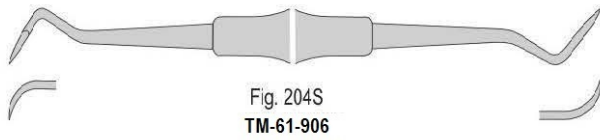
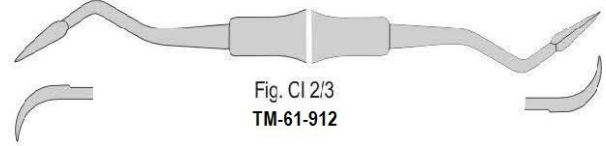
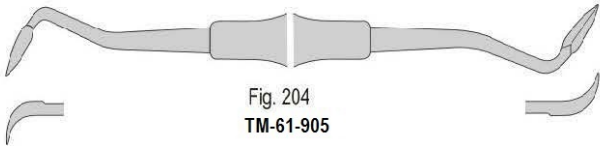


Fig. 7/8
TM-60-904
Younger-Good

Hollow Handle





Single Ended Solid Handle



Darby Perry

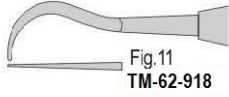


Fig. 11
TM-62-918

Hygienist

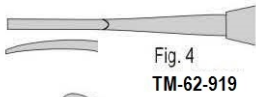


Fig. 4
TM-62-919

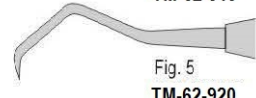


Fig. 5
TM-62-920

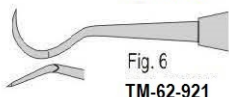


Fig. 6
TM-62-921

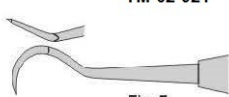


Fig. 7
TM-62-922

Jacquette

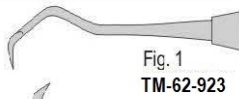


Fig. 1
TM-62-923

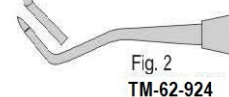


Fig. 2
TM-62-924

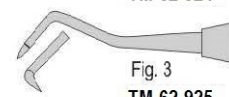


Fig. 3
TM-62-925

Standard

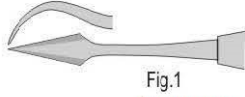


Fig. 1
TM-62-926



Fig. 2
TM-62-927

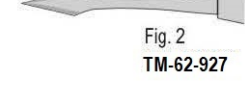


Fig. 3
TM-62-928



Fig. 4
TM-62-929



Fig. 6
TM-62-930

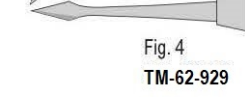


Fig. 7
TM-62-931

Standard

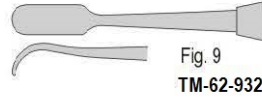


Fig. 9
TM-62-932

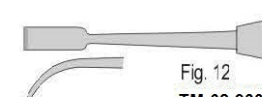


Fig. 12
TM-62-933

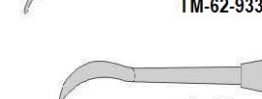


Fig. 32
TM-62-934



Fig. 33
TM-62-935

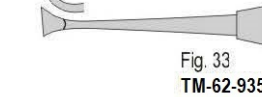


Fig. 34
TM-62-936



Fig. 33 1/2
TM-62-937



Fig. 34 1/2
TM-62-938

Palma

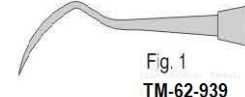


Fig. 1
TM-62-939

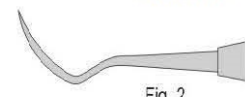


Fig. 2
TM-62-940

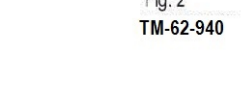


Fig. 4
TM-62-941

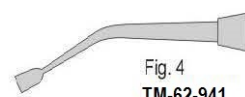


Fig. 5
TM-62-942



Fig. 6
TM-62-943

Towner

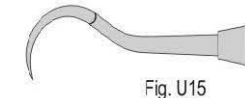
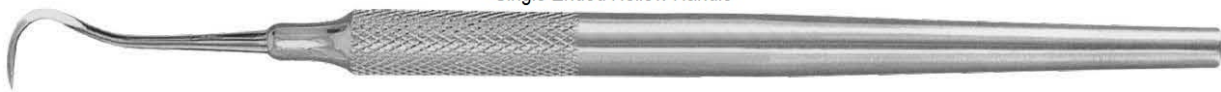


Fig. U15
TM-62-944

Single Ended Hollow Handle



Hygienist

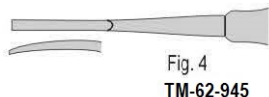


Fig. 4
TM-62-945

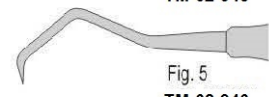


Fig. 5
TM-62-946

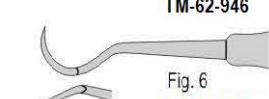


Fig. 6
TM-62-947



Fig. 7
TM-62-948

Jacquette

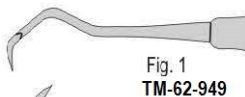


Fig. 1
TM-62-949

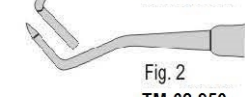


Fig. 2
TM-62-950

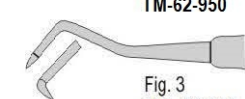


Fig. 3
TM-62-951

Towner

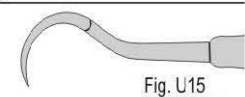


Fig. U15
TM-62-952

Standard

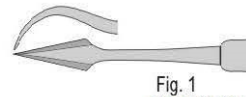


Fig. 1
TM-62-953

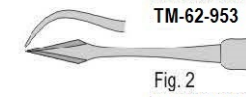


Fig. 2
TM-62-954

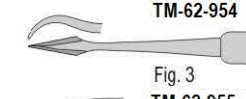


Fig. 3
TM-62-955

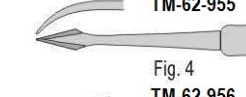


Fig. 4
TM-62-956

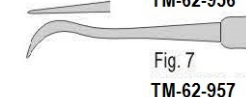


Fig. 7
TM-62-957

Standard

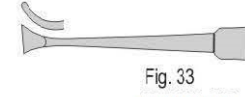


Fig. 33
TM-62-958

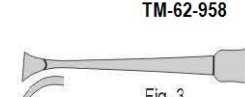


Fig. 3
TM-62-959

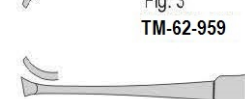
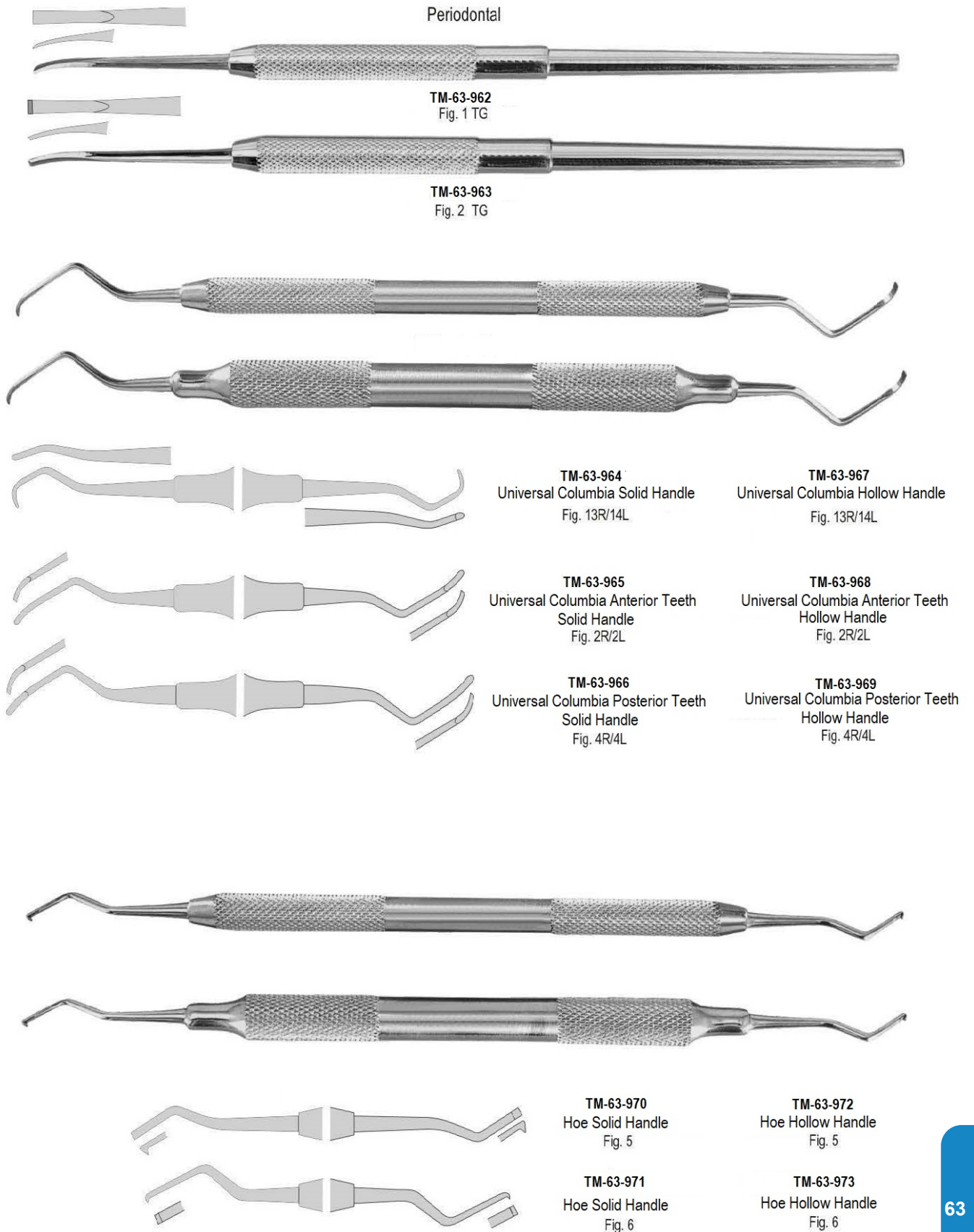


Fig. 33 1/2
TM-62-960

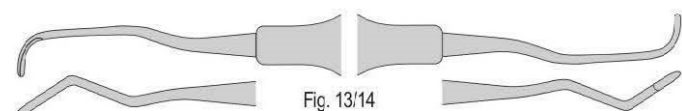
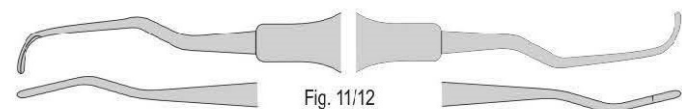
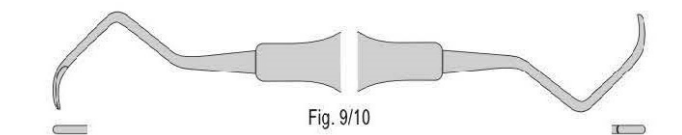
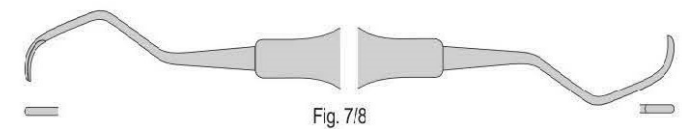
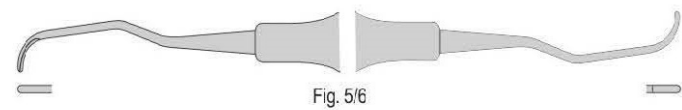
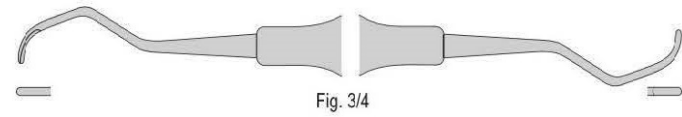
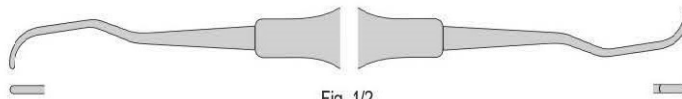


Fig. 34 1/2
TM-62-961





Gracey



| | |
|--------------------------------|------------------|
| Gracey Solid Handle Fig. 1/2 | TM-64-974 |
| Gracey Solid Handle Fig. 3/4 | TM-64-975 |
| Gracey Solid Handle Fig. 5/6 | TM-64-976 |
| Gracey Solid Handle Fig. 7/8 | TM-64-977 |
| Gracey Solid Handle Fig. 9/10 | TM-64-978 |
| Gracey Solid Handle Fig. 11/12 | TM-64-979 |
| Gracey Solid Handle Fig. 13/14 | TM-64-980 |

TM-64-980-S
Gracey Solid Handle set of 7 pieces



| | |
|---------------------------------|------------------|
| Gracey Hollow Handle Fig. 1/2 | TM-64-981 |
| Gracey Hollow Handle Fig. 3/4 | TM-64-982 |
| Gracey Hollow Handle Fig. 5/6 | TM-64-983 |
| Gracey Hollow Handle Fig. 7/8 | TM-64-984 |
| Gracey Hollow Handle Fig. 9/10 | TM-64-985 |
| Gracey Hollow Handle Fig. 11/12 | TM-64-986 |
| Gracey Hollow Handle Fig. 13/14 | TM-64-987 |

TM-64-987-S
Gracey Hollow Handle set of 7 pieces



Gracey Silicon Handle



Fig. 3/4
TM-65-989
Black



Fig. 5/6
TM-65-990
Yellow



Fig. 7/8
TM-65-991
Green



Fig. 9/10
TM-65-992
Red



Fig. 11/12
TM-65-993
Orange



Fig. 13/14
TM-65-994
Blue

Gracey Silicon Handle



Fig. 15/16
TM-65-995
Coffee

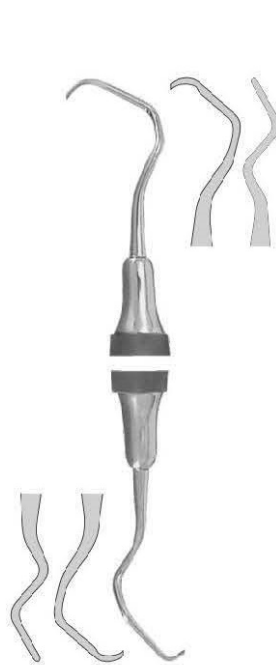


Fig. 17/18
TM-65-996
Light Blue



Fig. 11/14
TM-65-997
Blue



Fig. 12/13
TM-65-998
Orange

Fig. 1/2
TM-65-988
Grey

TM-65-999-S
Gracey Silicon Handle Set of 7 pieces





Gracey Silicon Handle



Fig. 1/2
TM-66-1000

Grey



Fig. 3/4
TM-66-1001

Black



Fig. 5/6
TM-66-1002

Yellow



Fig. 7/8
TM-66-1003

Green



Fig. 9/10
TM-66-1004

Red



Fig. 11/12
TM-66-1005

Orange



Fig. 13/14
TM-66-1006

Blue

TM-66-1007-S
Gracey Silicon Handle Set of 7 pieces



Sollid Handle

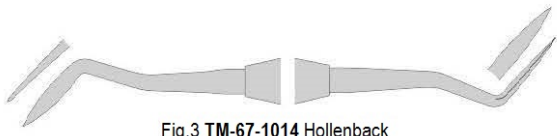


Fig.3 TM-67-1014 Hollenback



Fig.2/3 TM-67-1018 Frahm

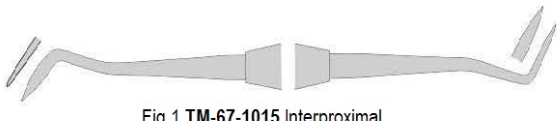


Fig.1 TM-67-1015 Interproximal

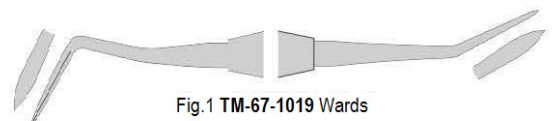


Fig.1 TM-67-1019 Wards

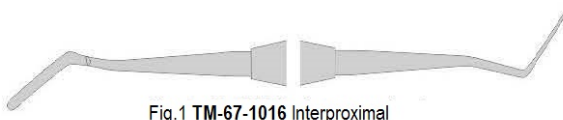


Fig.1 TM-67-1016 Interproximal

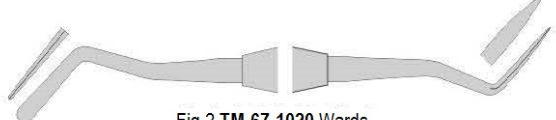


Fig.2 TM-67-1020 Wards

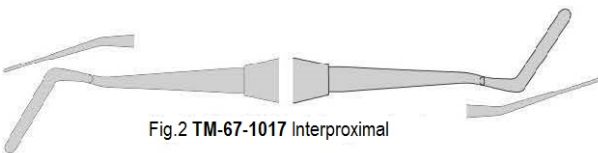


Fig.2 TM-67-1017 Interproximal

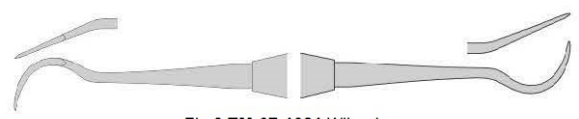


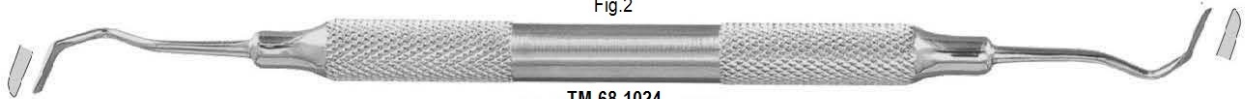
Fig.8 TM-67-1021 Wiland



TM-68-1022
Tanner Hollow handle
Fig.6T



TM-68-1023
USC Hollow handle
Fig.2



TM-68-1024
USC Hollow handle
Fig.2S



Cleoid - Discoid Solid handle

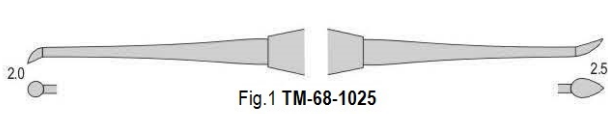


Fig.1 TM-68-1025

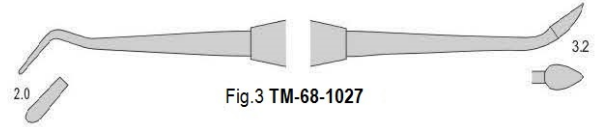


Fig.3 TM-68-1027

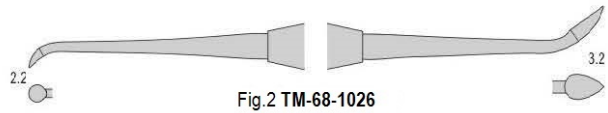


Fig.2 TM-68-1026

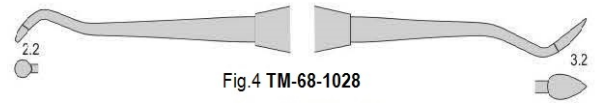


Fig.4 TM-68-1028



Cleoid - Discoid Hollow Handle



Fig.4/5 TM-68-1029

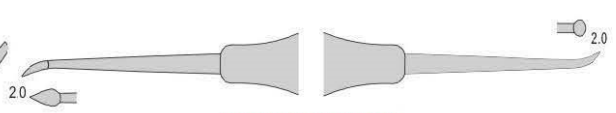


Fig.89/92 TM-68-1031

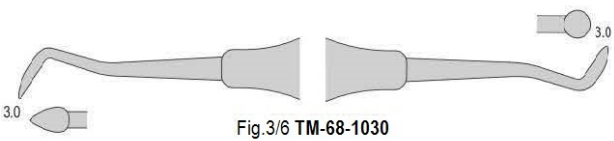


Fig.3/6 TM-68-1030

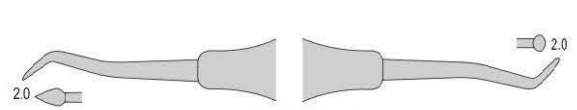


Fig.90B TM-68-1032

P.K. Thomas Hollow Handle



Fig.1 TM-69-1033



Fig.2 TM-69-1034



Fig.4 TM-69-1036

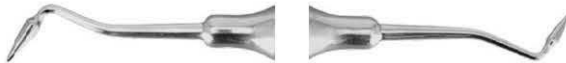


Fig.3 TM-69-1035

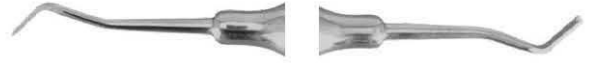


Fig.5 TM-69-1037

P.K. Thomas Solid Handle



Fig.1 TM-69-1038



Fig.2 TM-69-1039



TM-69-1043-S
P.k. Thomas
Set of 5 Pieces



Fig.4 TM-69-1041



Fig.3 TM-69-1040



Fig.5 TM-69-1042



TM-69-1044
Beale Hollow handle
Fig.7



Fig.31 TM-69-1045 Gritman Hollow handle



Fig.10 TM-69-1047 Le cron Hollow handle



Fig.10 TM-69-1046 Hylin Hollow handle



Fig.10 TM-69-1048 Zahle Hollow handle

Solid Handle



TM-69-1049
Vehe Solid Handle
Fig.1



TM-69-1050
Gritman Solid Handle
Fig.31



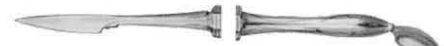
TM-69-1052
Solid Handle
Fig.10



TM-69-1053
Beale Solid Handle
Fig.7



TM-69-1051
Solid Handle
Fig.12



TM-69-1054
Roach Solid Handle
Fig.1



Fig. 1 13 cm



Fig. 2 14 cm



Fig. 3 14 cm



Fig. 4 13.5 cm



Fig. 5 14 cm



Fig. 6 11.7 cm



Fig. 7 15 cm



Fig. 1 Zahle 12 cm



Fig. 2 Zahle 12.5 cm



Fig. 3 Zahle 12.5 cm



Fig. 4 Zahle 12 cm



Fig. 5 Zahle 12 cm



Fig. 6 Zahle 11.5 cm

TM-70-1055

TM-70-1056

TM-70-1057

TM-70-1058

TM-70-1059

TM-70-1060

TM-70-1061

TM-70-1062

TM-70-1063

TM-70-1064

TM-70-1065

TM-70-1066

TM-70-1067



Fig. 1 Hylin 13.5 cm



Fig. 3 Hylin-Ceramica 13.5 cm



Fig. 5 Hylin 13.5 cm



Fig. 6 Hylin-Lecron 13.5 cm



Fig. 1 Lecron-mini 10 cm



Fig. 2 Lecron-mini 13 cm



Fig. 3 Lecron-mini 13 cm



Fig. 1 Lecron 16.5 cm



Fig. 2 Lecron 16.5 cm



Fig. 3 Lecron 16.5 cm



Fig. 4 Lecron 16.5 cm



Fig. 7 Lecron 16 cm



Fig. 8 Lecron 16 cm

TM-70-1068

TM-70-1069

TM-70-1070

TM-70-1071

TM-70-1072

TM-70-1073

TM-70-1074

TM-70-1075

TM-70-1076

TM-70-1077

TM-70-1078

TM-70-1079

TM-70-1080

Double Ended Hollow Handle



Fig.1 TM-71-1081



Fig.2 TM-71-1082



Fig.3 TM-71-1083

Double Ended Solid Handle



Fig.1 TM-71-1084



Fig.2 TM-71-1085



Fig.3 TM-71-1086

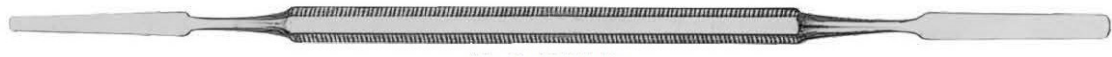


Fig.00 TM-71-1087

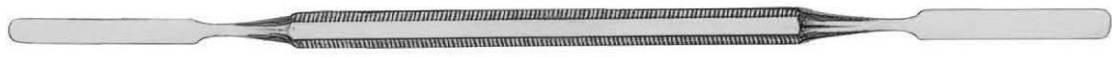


Fig.0 TM-71-1088

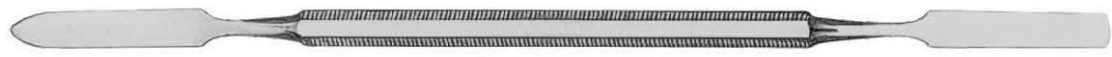


Fig.1 TM-71-1089



Fig.2 TM-71-1090

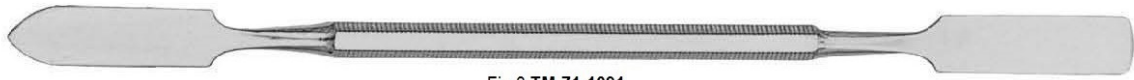


Fig.3 TM-71-1091

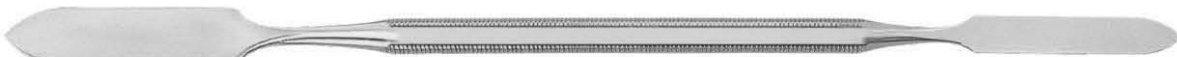


Fig.4 TM-71-1092



Weston TM-71-1093

Single Ended Solid Handle



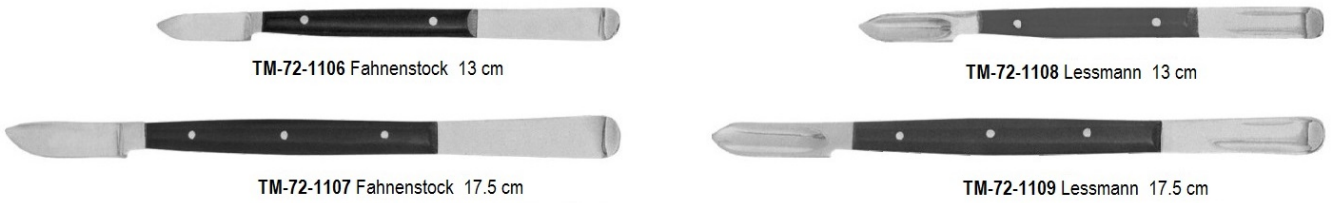
TM-71-1094



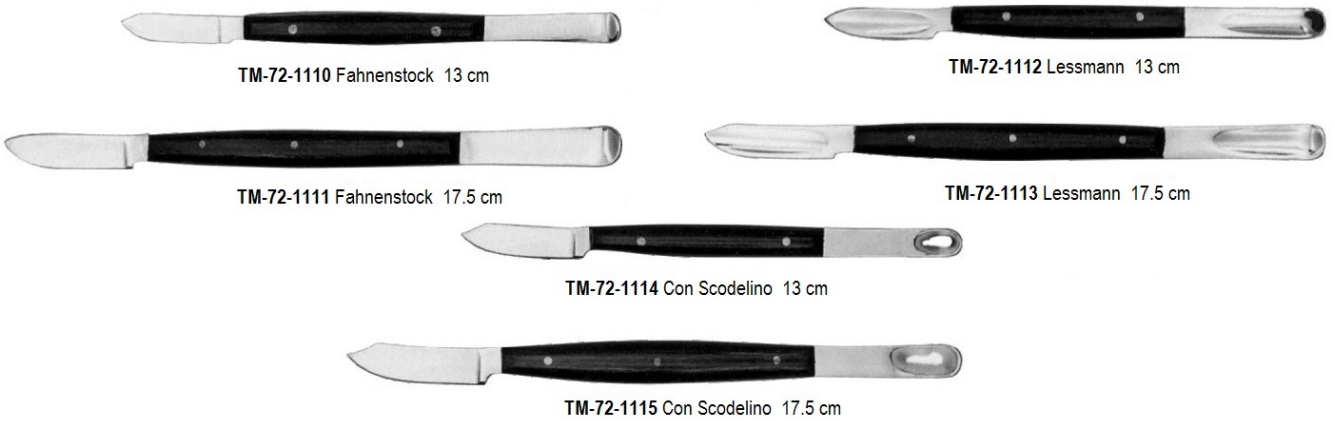
Plaster with wooden handle



Plastic Handle



wooden handle



Ermert



metal handle



Plaster Flexible Wooden Handle



21 cm

TM-73-1123



21 cm

TM-73-1124



21.5 cm

TM-73-1125



20 cm

TM-73-1126



19 cm

TM-73-1127



23 cm

TM-73-1128



21 cm

TM-73-1129



Roghe 20 cm

TM-73-1130



Lichtenstein 17 cm

TM-73-1131



18 cm

TM-73-1132



18.5 cm

TM-73-1133

Plaster Rigid

Plaster Rigid Wooden Handle

Page 74-83

- o DENTAL ELEVATOR

Root
Luxators

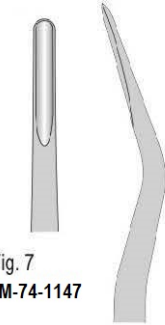
Fig. 1
TM-74-1141

Fig. 2
TM-74-1142

Fig. 3
TM-74-1143

Fig. 4
TM-74-1144

Fig. 5
TM-74-1145

Fig. 6
TM-74-1146

Fig. 7
TM-74-1147

TM-74-1150-S
Set of 7 Pcs
Bein

Fig. 1
TM-74-1151

Fig. 2
TM-74-1152

Fig. 3
TM-74-1153

Fig. 4
TM-74-1154

Fig. 5
TM-74-1155

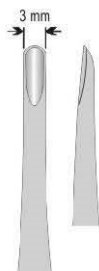
Fig. 6
TM-74-1156
Apical

Fig. 301
TM-74-1157

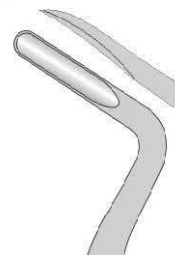
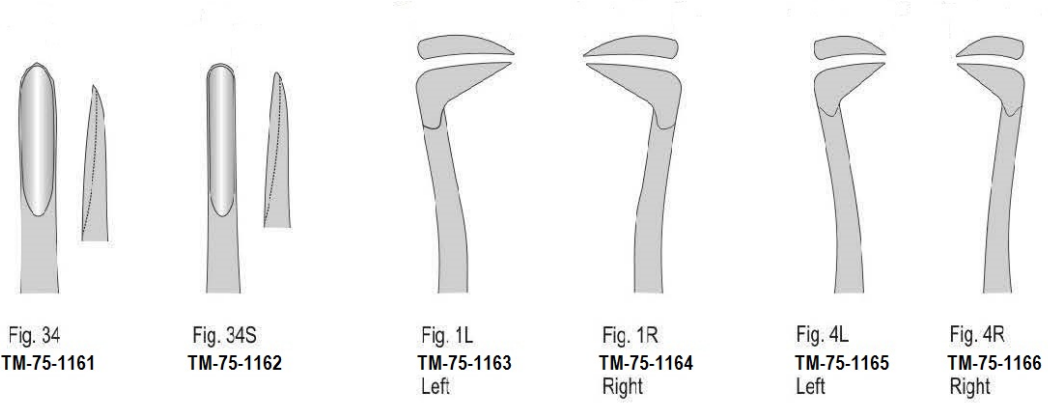
Fig. 302
TM-74-1158
Left

Fig. 303
TM-74-1159
Right

Fig. 304
TM-74-1160

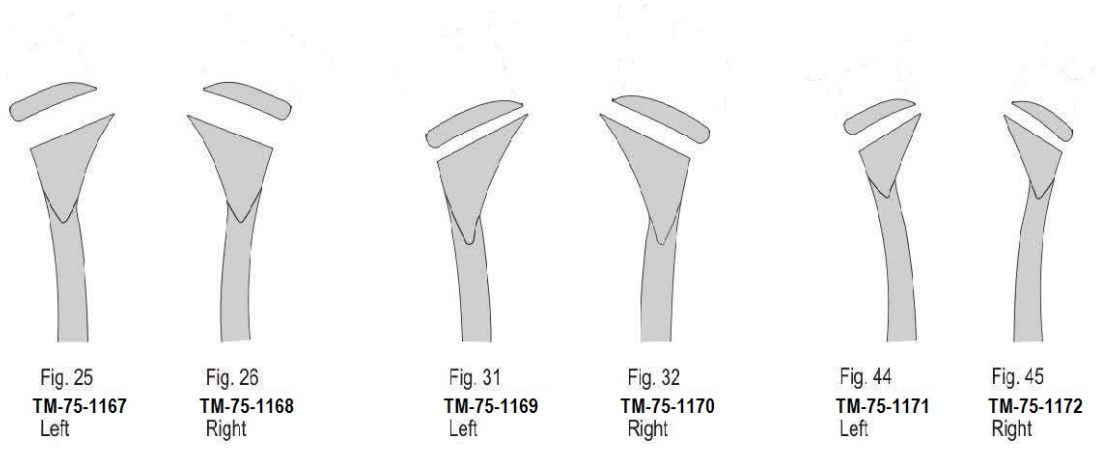


Root

Seldin

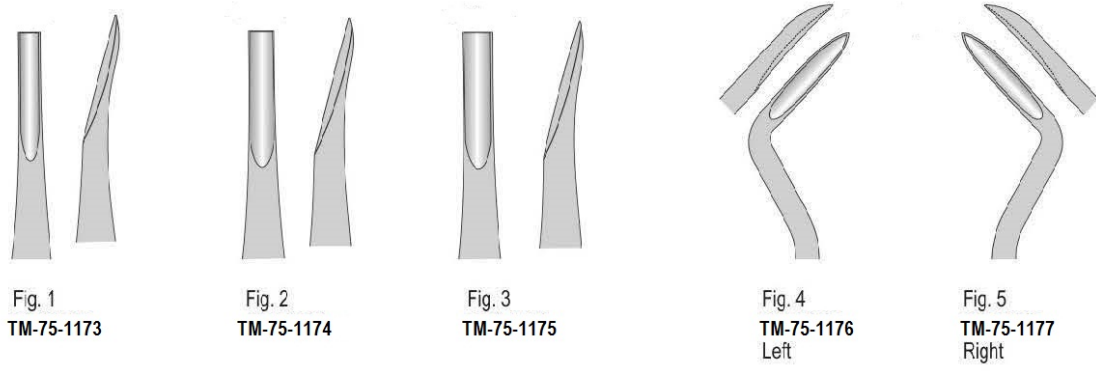


Cryer



Coupland

Schmeckebier



Root Bien

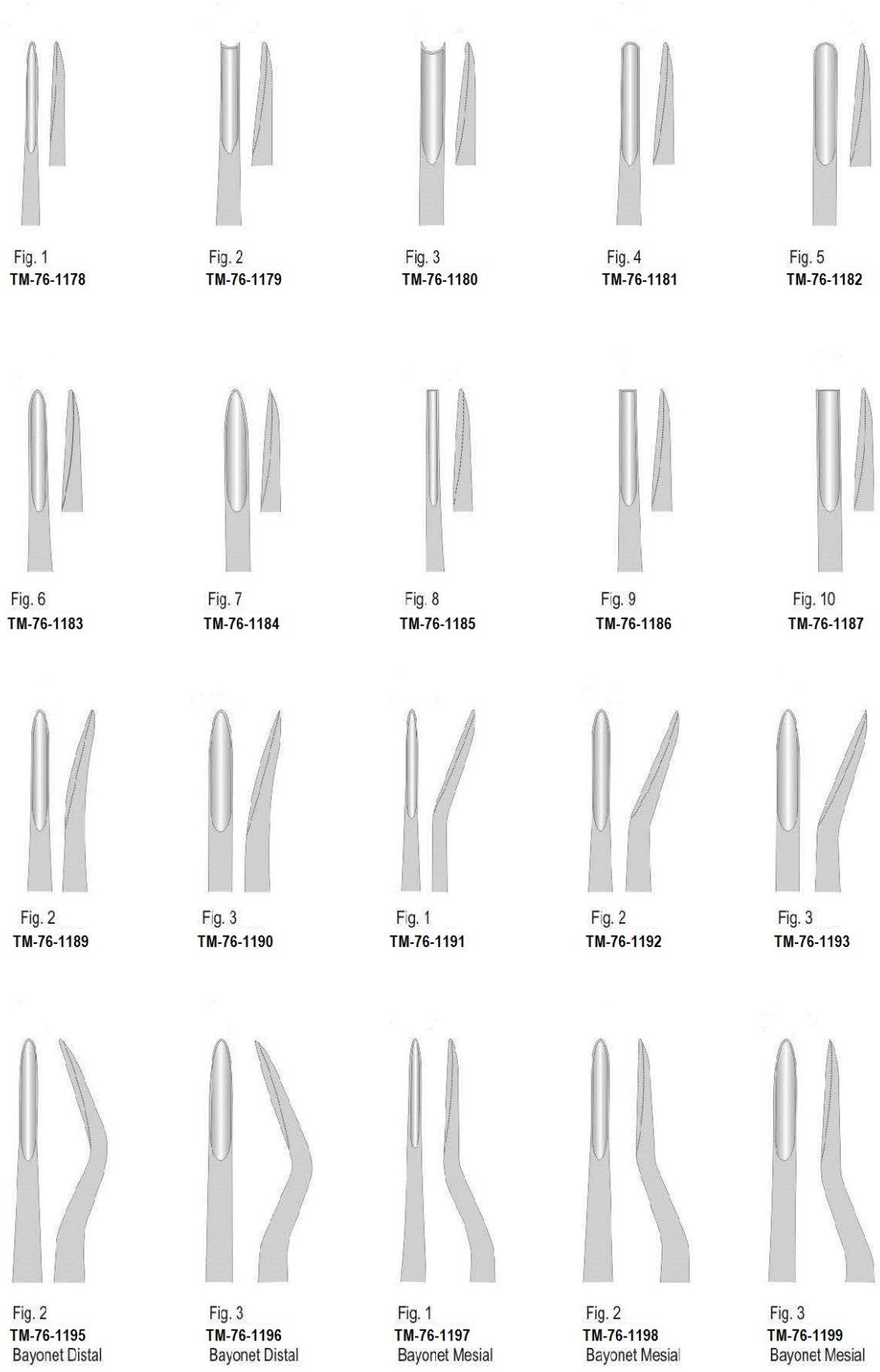


Fig. 1
TM-76-1178

Fig. 2
TM-76-1179

Fig. 3
TM-76-1180

Fig. 4
TM-76-1181

Fig. 5
TM-76-1182

Fig. 6
TM-76-1183

Fig. 7
TM-76-1184

Fig. 8
TM-76-1185

Fig. 9
TM-76-1186

Fig. 10
TM-76-1187

Fig. 1
TM-76-1188

Fig. 2
TM-76-1189

Fig. 3
TM-76-1190

Fig. 1
TM-76-1191

Fig. 2
TM-76-1192

Fig. 3
TM-76-1193

Fig. 1
TM-76-1194
Bayonet Distal

Fig. 2
TM-76-1195
Bayonet Distal

Fig. 3
TM-76-1196
Bayonet Distal

Fig. 1
TM-76-1197
Bayonet Mesial

Fig. 2
TM-76-1198
Bayonet Mesial

Fig. 3
TM-76-1199
Bayonet Mesial



Root



Flohr

Friedman



Fig. 1
TM-77-1200

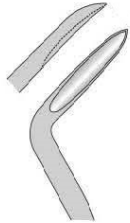


Fig. 2
TM-77-1201
Left

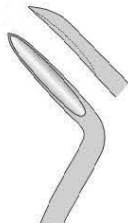


Fig. 3
TM-77-1202
Right



Fig. 1
TM-77-1203



Fig. 2
TM-77-1204
Left



Fig. 3
TM-77-1205
Right

Lindo-Levian



Fig. LLL
TM-77-1206

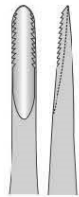


Fig. LLM
TM-77-1207

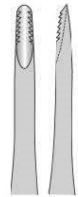


Fig. LLS
TM-77-1208

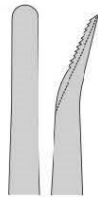


Fig. LLL
TM-77-1209

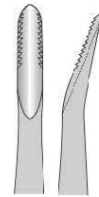


Fig. LLM
TM-77-1210



Fig. LLS
TM-77-1211

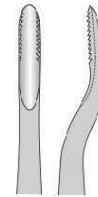


Fig. LLM
TM-77-1212
Bayonet Distal

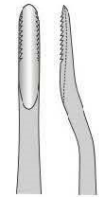


Fig. LLM
TM-77-1213
Bayonet Mesial

Hysin

Bein

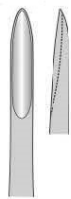


Fig. 1
TM-77-1214



Fig. 2
TM-77-1215



Fig. 1
TM-77-1218



Fig. 6
TM-77-1219



Fig. 7
TM-77-1220

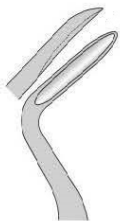


Fig. 3
TM-77-1216
Left

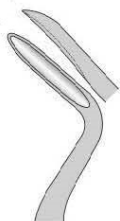


Fig. 4
TM-77-1217
Right



Fig. 1
TM-77-1221



Fig. 2
TM-77-1222
Left

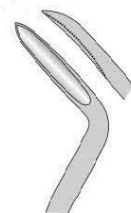


Fig. 3
TM-77-1223
Right

Flohr

Root

Schlemmer

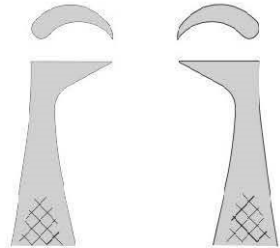


Fig. 1
TM-78-1224
Left

Fig. 2
TM-78-1225
Right

Schlemmer



Fig. 1
TM-78-1226
Left

Fig. 2
TM-78-1227
Right

Coleman / London Hospital



Fig. 20
TM-78-1228
Coleman

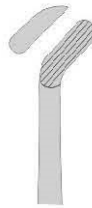


Fig. 21
TM-78-1229
London Hospital
Left

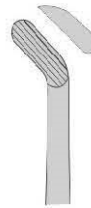


Fig. 22
TM-78-1230
London Hospital
Right

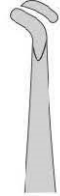
Warwick-James



TM-78-1231
Straight



TM-78-1232
Left



TM-78-1233
Right

Root Tip Picks / Heidebrink

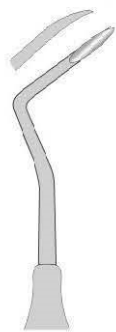


Fig. 2
TM-78-1235
Left



Fig. 1
TM-78-1234



Fig. 3
TM-78-1236
Right

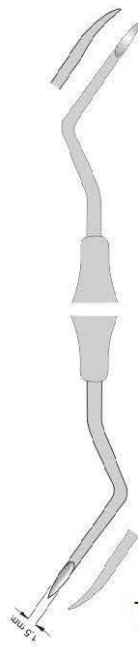


Fig. 13/14
TM-78-1237
Double ended



Fig. 2
TM-78-1239
Left



Fig. 1
TM-78-1238

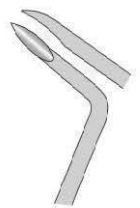
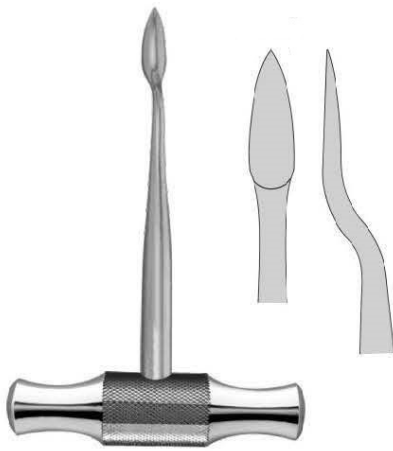


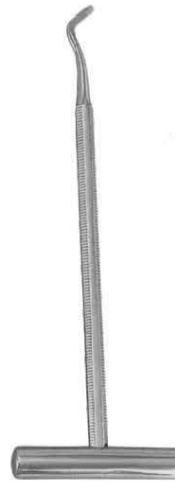
Fig. 3
TM-78-1240
Right



Root



TM-79-1241
Lecluse Fig. 1



Potts



Fig. 6
TM-79-1241
Left

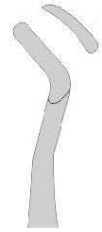


Fig. 7
TM-79-1242
Right

Winter

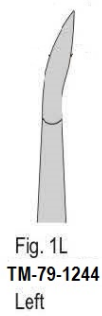
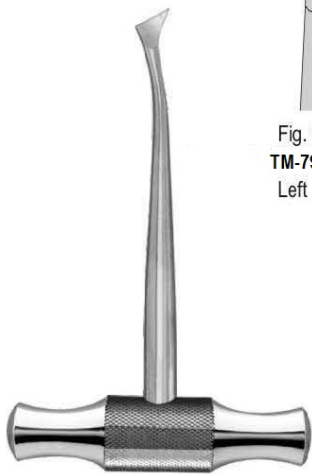


Fig. 1L
TM-79-1244
Left

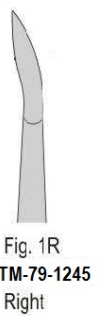


Fig. 1R
TM-79-1245
Right

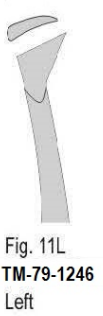


Fig. 11L
TM-79-1246
Left

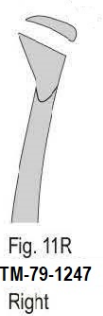


Fig. 11R
TM-79-1247
Right



Fig. 12L
TM-79-1248
Left

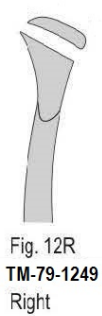


Fig. 12R
TM-79-1249
Right

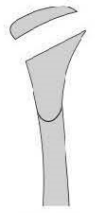


Fig. 13L
TM-79-1250
Left

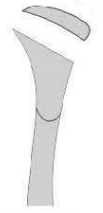


Fig. 13R
TM-79-1251
Right

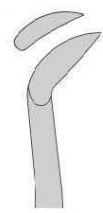


Fig. 13L
TM-79-1252
Left

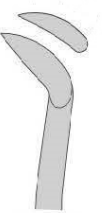


Fig. 13R
TM-79-1253
Right

Walter F. Barry

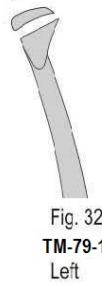


Fig. 320
TM-79-1254
Left

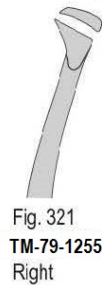


Fig. 321
TM-79-1255
Right



Fig. 322
TM-79-1256
Left



Fig. 323
TM-79-1257
Right

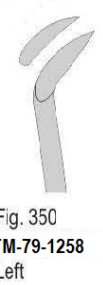


Fig. 350
TM-79-1258
Left



Fig. 351
TM-79-1259
Right

Dental Elevator

Root



Fig. 1
TM-80-1260



Fig. 2
TM-80-1261



Fig. 3
TM-80-1262

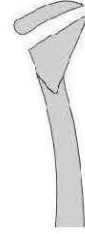


Fig. 44
TM-80-1263
Left

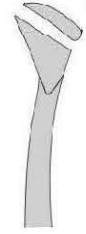


Fig. 45
TM-80-1264
Right

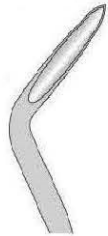


Fig. 2
TM-80-1265
Left



Fig. 3
TM-80-1266
Right



TM-80-1267-S
Set of 7 Pcs

Anatomical Handle



Fig. 1
TM-80-1268



Fig. 2
TM-80-1269



Fig. 3
TM-80-1270

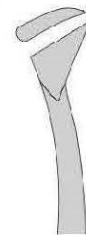


Fig. 44
TM-80-1271
Left



Fig. 45
TM-80-1272
Right

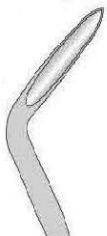


Fig. 2
TM-80-1273
Left



Fig. 3
TM-80-1274
Right



TM-80-1275-S
Set of 7 Pcs



Root

Children Handle



Fig. 1
TM-81-1276



Fig. 2
TM-81-1277



Fig. 3
TM-81-1278

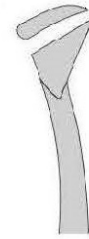


Fig. 44
TM-81-1279
Left



Fig. 45
TM-81-1280
Right



Fig. 2
TM-81-1281
Left



Fig. 3
TM-81-1282
Right



TM-81-1283-S
Set of 7 Pcs

Chompret



Fig. 1
TM-81-1284



Fig. 2
TM-81-1285



Fig. 3
TM-81-1286



Fig. 4
TM-81-1287



Root

Serrated Titanium Coated

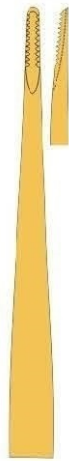


Fig. 1
TM-82-1288



Fig. 2
TM-82-1289



Fig. 1
TM-82-1290

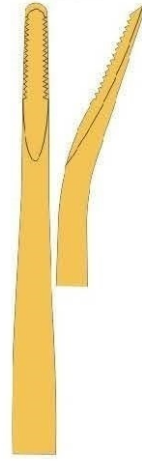


Fig. 3
TM-82-1291



Fig. 4
TM-82-1292



Fig. 6
TM-82-1293



Fig. 7
TM-82-1294

TM-82-1295-S Set of 7 Pcs

Luxators Titanium Coated



Fig. 1
TM-82-1296



Fig. 2
TM-82-1297

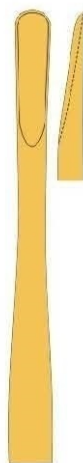


Fig. 3
TM-82-1298

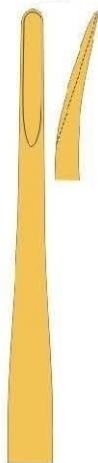


Fig. 4
TM-82-1299

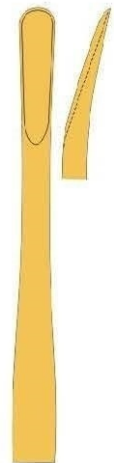


Fig. 5
TM-82-1300

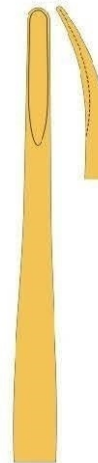


Fig. 6
TM-82-1301

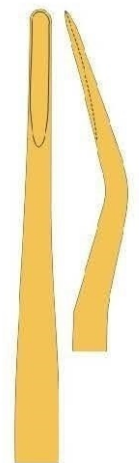


Fig. 7
TM-82-1302

TM-82-1303-S Set of 7 Pcs





Root

Titanium Coated

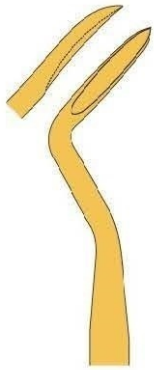


Fig. 2
TM-83-1304
Flohr

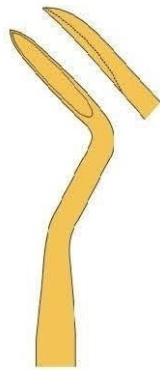


Fig. 3
TM-83-1305
Flohr



Fig. 1
TM-83-1306
Bein

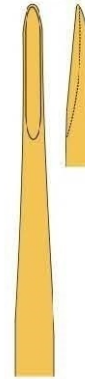


Fig. 6
TM-83-1307
Bein



Fig. 7
TM-83-1308
Bein

TM-83-1309-S Set of 5 Pcs

British Models Titanium Coated

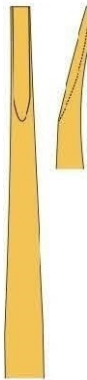


Fig. 1
TM-83-1310
Coupland

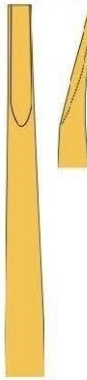
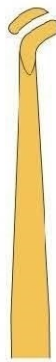


Fig. 2
TM-83-1311
Coupland



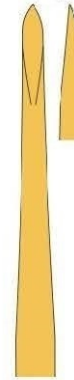
Fig. 3
TM-83-1312
Coupland



TM-83-1313
Warwick-James



TM-83-1314
Warwick-James



TM-83-1315
Warwick-James

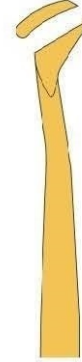


Fig. 30
TM-83-1316
Cryer

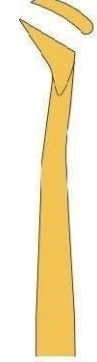


Fig. 31
TM-83-1317
Cryer

TM-83-1318-S Set of 8 Pcs

Titanium Coated

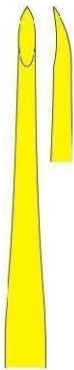


Fig. 1
TM-83-1319
Heidebrink

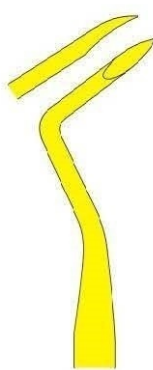


Fig. 2
TM-83-1320
Heidebrink

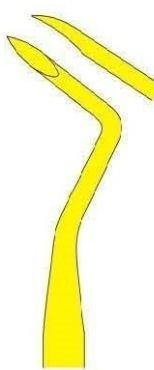


Fig. 3
TM-83-1321
Heidebrink



Fig. 11
TM-83-1322
Bernhard

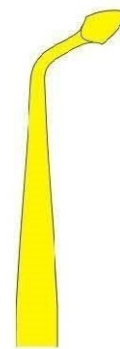


Fig. 6
TM-83-1323
Bernhard



Fig. 7
TM-83-1324
Bernhard

TM-83-1324-S Set of 6 Pcs

Page

84-110

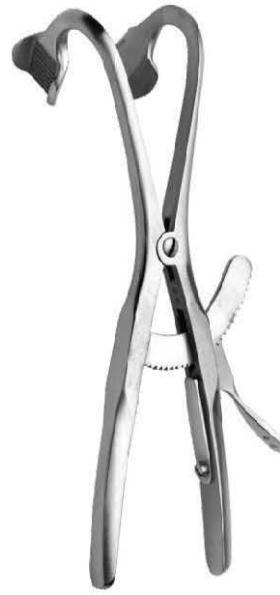
- MOUTH GAG
- TONGUE DEPRESSOR
- HAND-HELD RETRACTOR
- TISSUE FORCEPS SCISSORS
- DENTAL DRESSING FORCEPS
- DRESSING FORCEPS TWEEZERS
- CHISEL
- BONE FILE/RASP
- DENTAL ELEVATOR
- DENTAL OSTEOTOME
- PERIODONTAL CURETTE
- BONE CURETTE
- ORTHODONTIC GAUGE
- MALLET
- PERIOSTEAL ELEVATOR
- HOOKS
- SELF-REATAINING RETRACTOR
- SURGICAL PROBE
- SUCTION TUBES



Molt
TM-84-1325 10 cm
TM-84-1326 11 cm
TM-84-1327 14 cm



Roser-König
TM-84-1328 16 cm
TM-84-1329 19 cm



TM-84-1330
Denhardt
13 cm



TM-84-1331
Fergusson - Ackland
14.5 cm



TM-84-1332
Heister
Maunder Wood
9.5 cm



TM-84-1333
Obwegeser 11 cm
Spreading 47 mm



TM-84-1334
Heister
13 cm



Fig. 1
Davis-Boyle
TM-85-1335
110 x 28 mm



Fig. 2
Davis-Boyle
TM-85-1336
95 x 27 mm



Fig. 3
Davis-Boyle
TM-85-1337
80 x 27 mm



Fig. 4
Davis-Boyle
TM-85-1338
65 x 26 mm



Fig. 5
Davis-Boyle
TM-85-1339
30 x 20 mm



TM-85-1340
Davis-Boyle
Complete, consisting of frame
& 5 tongue depressors No. 1 to 5



TM-86-1341
Mc-Ivor
Frame



Fig. 1
TM-86-1342
100 x 25 mm

Fig. 2
TM-86-1343
85 x 25 mm

Fig. 3
TM-86-1344
75 x 25 mm

TM-86-1345
Mc-Ivor
Complete, with 3 tongue depressors



TM-86-1346
Dingmann
Complete, with frame, 3 tongue depressors,
& 2 adjustable lateral blades



Dingmann

Fig. 1
TM-86-1347
62 x 26 mm

Fig. 2
TM-86-1348
65 x 30 mm

Fig. 3
TM-86-1349
78 x 32 mm



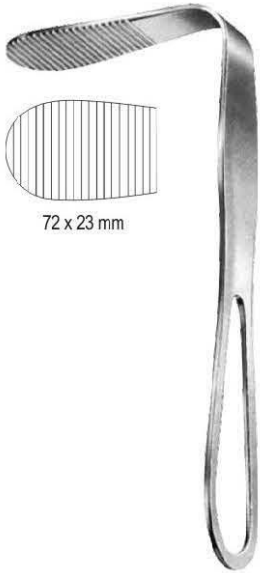
Jennings
TM-87-1350 10.5 cm
TM-87-1351 12.5 cm
TM-87-1352 14.5 cm
TM-87-1353 16.5 cm



Whitehead
TM-87-1354 11 cm
TM-87-1355 13 cm
TM-87-1356 15 cm



Cheek
TM-87-1357 Small
TM-87-1358 Medium
TM-87-1359 Large



72 x 23 mm

TM-88-1360
Hartmann
15 cm



TM-88-1361
Doyen Tongue Spatula
13.5 cm



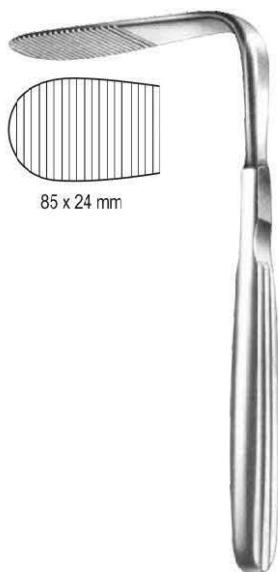
TM-88-1362
14.5 cm



TM-88-1363
18 cm

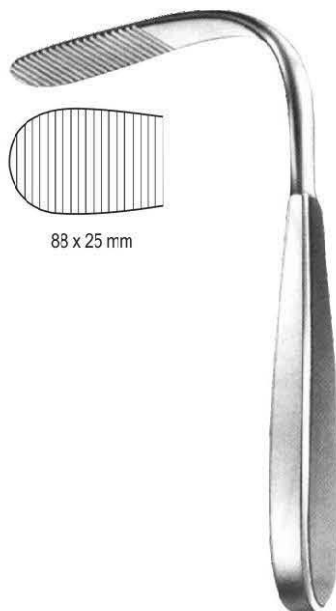


TM-88-1364
Bruenings
19 cm



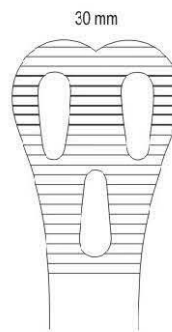
85 x 24 mm

TM-88-1365
Tobold
15 cm



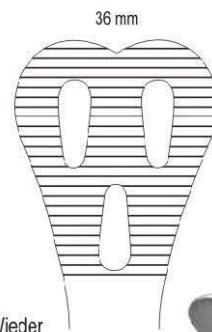
88 x 25 mm

TM-88-1366
Tobold
16 cm



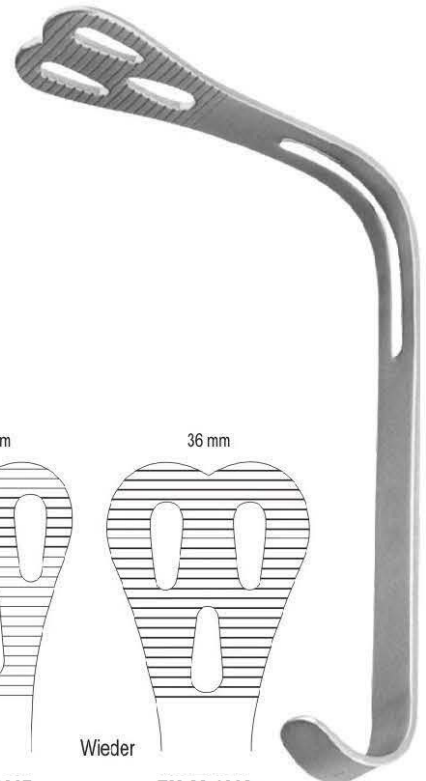
30 mm

TM-88-1367
14 cm



36 mm

TM-88-1368
15 cm



Wieder



Hand-Held Retractor



TM-89-1369
Obwegeser Chin
16.5 cm



Obwegeser 16 cm
TM-89-1370 8 mm
TM-89-1371 10 mm



TM-89-1372 43 x 11 mm
TM-89-1373 57 x 11 mm
TM-89-1374 83 x 16 mm

Obwegeser soft
Tissue
21.5 cm



Obwegeser
TM-89-1375
Spina-nasalis
22 cm



Obwegeser
TM-89-1376
Ramus tissue
22 cm



TM-89-1377
Simplex
10.5 cm



TM-89-1378
Kilner
15 cm



TM-89-1379
Minnesota
14 cm



TM-89-1380
Cawood-Minnesota
15 cm



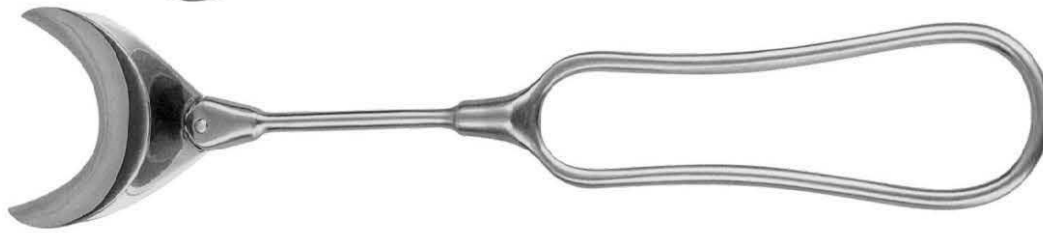
TM-89-1381
Austin



TM-90-1382
Hilger
Fits any simple stem



TM-90-1383
Hilger
with handle

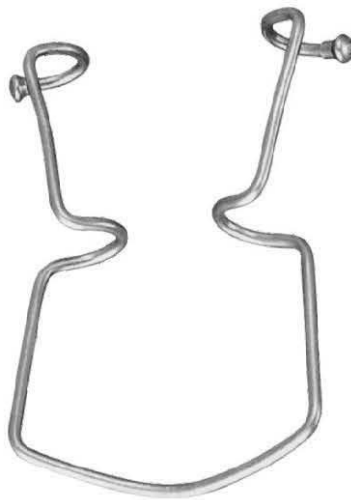


TM-90-1384
20 cm

Finger protectors



TM-90-1385 Small
TM-90-1386 Medium
TM-90-1387 Large



TM-90-1388
Oringer
11.5 cm



TM-90-1389
Obwegeser Cheek
12cm



TM-90-1390
Columbia
14.5 cm



Sternberg

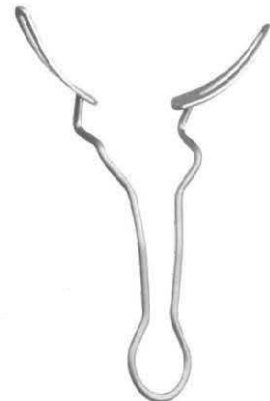
TM-90-1391 12 cm
TM-90-1392 14 cm
TM-90-1393 15 cm



Vestibulum
TM-90-1394



TM-90-1395
Implants



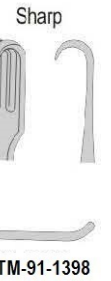
TM-90-1396
Implants



Hand-Held Retractor, Tissue Forceps Scissors



Senn-Miller
16 cm



TM-91-1399
Prong 1 Sharp



16 cm



TM-91-1403
Prong 1 Blunt



16 cm

Tissue Forceps Scissors



TM-91-1407
Collin Tongue holding
17 cm



Young Tongue holding
TM-91-1408 15 cm
TM-91-1409 17 cm



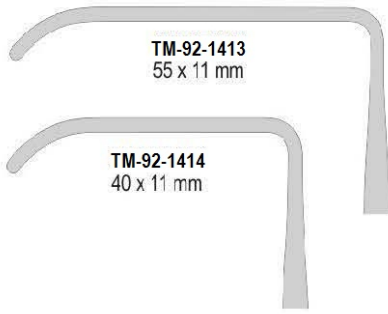
TM-91-1411
Farabeuf 12 cm
Pair



TM-91-1412
Parker-Langenbeck 21 cm
Pair

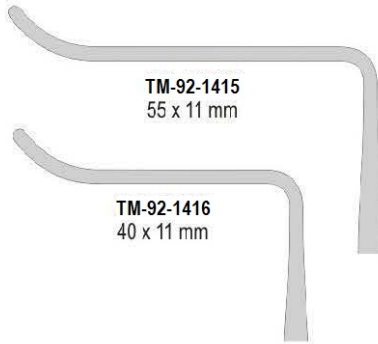


kocher
21.5 cm



TM-92-1413
55 x 11 mm

TM-92-1414
40 x 11 mm

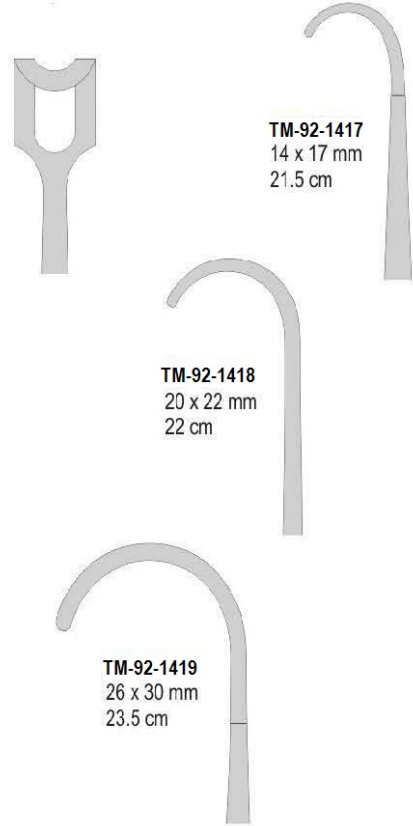


TM-92-1415
55 x 11 mm

TM-92-1416
40 x 11 mm



Middeldorph



TM-92-1417
14 x 17 mm
21.5 cm

TM-92-1418
20 x 22 mm
22 cm

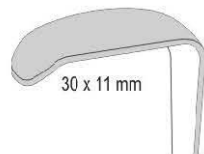
TM-92-1419
26 x 30 mm
23.5 cm



■ Langenbeck
22 cm

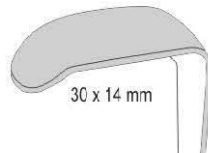


● Langenbeck
22 cm



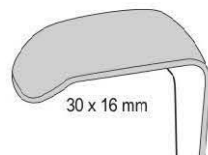
30 x 11 mm

■ TM-92-1420
● TM-92-1421



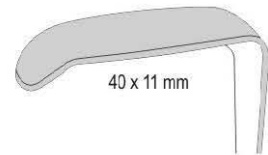
30 x 14 mm

■ TM-92-1422
● TM-92-1423



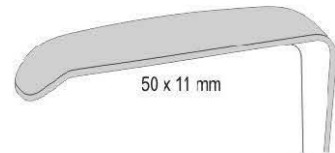
30 x 16 mm

■ TM-92-1424
● TM-92-1425



40 x 11 mm

■ TM-92-1426
● TM-92-1427

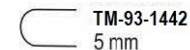
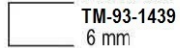
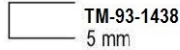
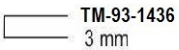
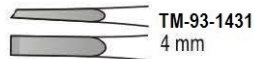


50 x 11 mm

■ TM-92-1428
● TM-92-1429

Chisel , Bone File/Rasp, Dental Dressing Forceps

Chisels



Osteotomes



Dental Dressing Forceps



TM-93-1448
Goldman-Fox
Left
Pocket Markers



TM-93-1449
Goldman-Fox
Right
Pocket Markers

Bone File/Rasp





PDL Elevators



TM-94-1457 Distal, 2.5 mm Micro Edge Blue Titanium Coated



TM-94-1458 Mesial, 2.5 mm Micro Edge Blue Titanium Coated



TM-94-1459 Distal, 4 mm Micro Edge Blue Titanium Coated



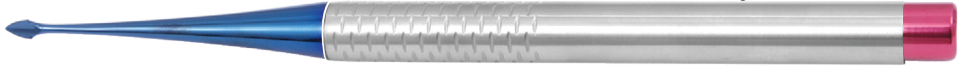
TM-94-1460 Mesial 4 mm Micro Edge Blue Titanium Coated



TM-94-1461 Straight 2.5 mm Micro Edge, Blue Titanium Coated



TM-94-1462 Curved 2.5 mm Micro Edge, Blue Titanium Coated



TM-94-1463 Straight 3.4 mm Micro Edge, Blue Titanium Coated

TM-94-1463-S Set Of 7 Pieces Blue Titanium Coated



TM-94-1464 Distal, 2.5 mm Micro Edge Golden Titanium Coated



TM-94-1465 Distal, 2.5 mm Micro Edge Golden Titanium Coated



TM-94-1466 Mesial, 2.5 mm Micro Edge Golden Titanium Coated



TM-94-1467 Mesial 4 mm Micro Edge Golden Titanium Coated



TM-94-1468 Straight 2.5 mm Micro Edge, Golden Titanium Coated



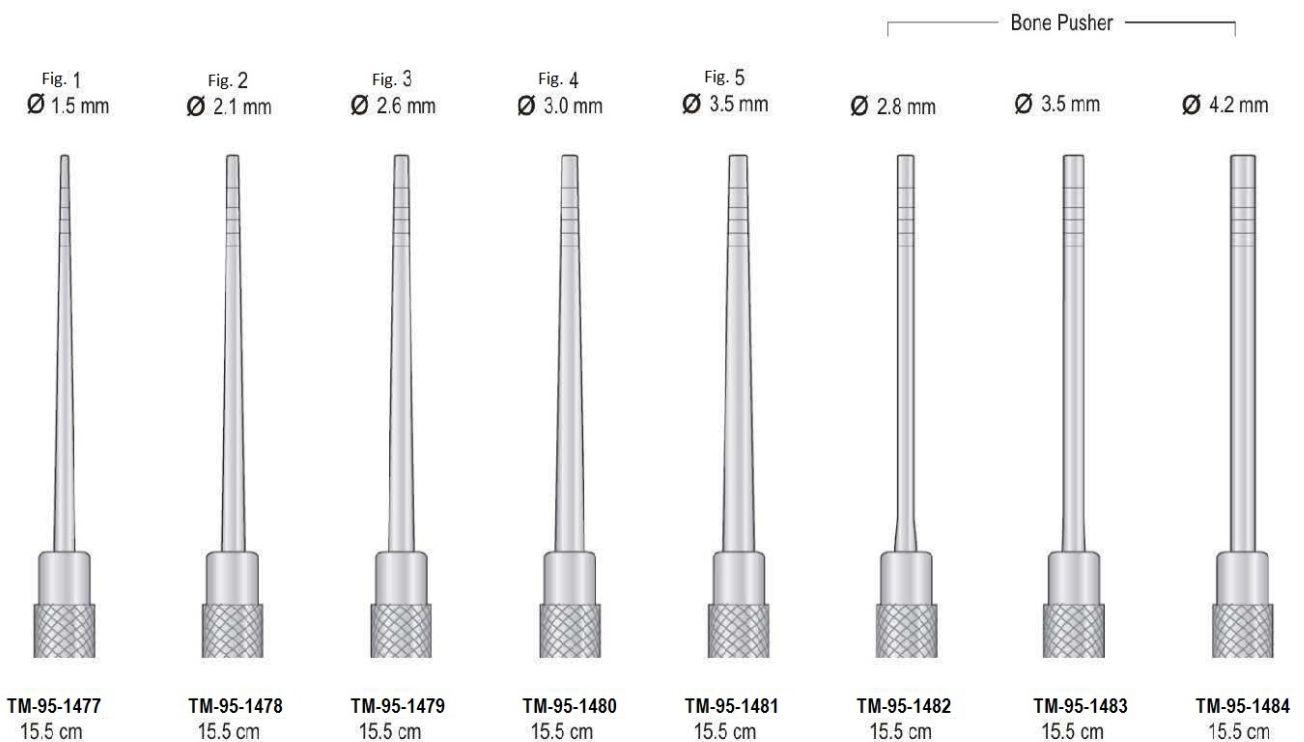
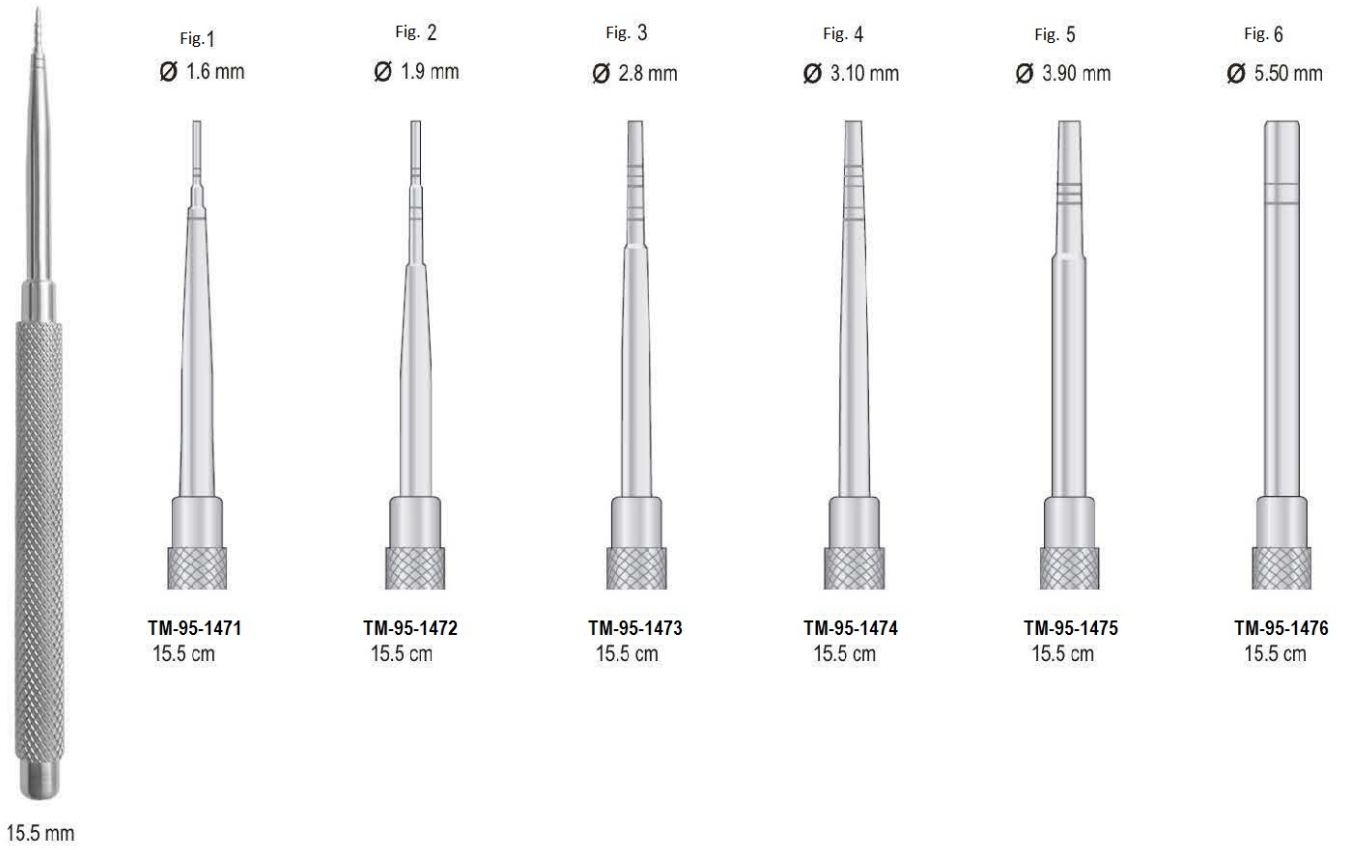
TM-94-1469 Curved 2.5 mm Micro Edge, Golden Titanium Coated



TM-94-1470 Straight 3.4 mm Golden Titanium Coated

TM-94-1470-S Set Of 7 Pieces Golden Titanium Coated

Osteotomes





TM-96-1485
Bone Collector Chisel Straight



TM-96-1487
Straight blade for bone collector



TM-96-1486
Bone Collector Chisel Curved



TM-96-1488
Curved blade for bone collector



TM-96-1489
Ratchet Screw driver handle
Hexagonal head



TM-96-1490
Bone Morselizer with Titanium Grinding



TM-96-1491
Bone Mixing Basin
Dia 35 mm



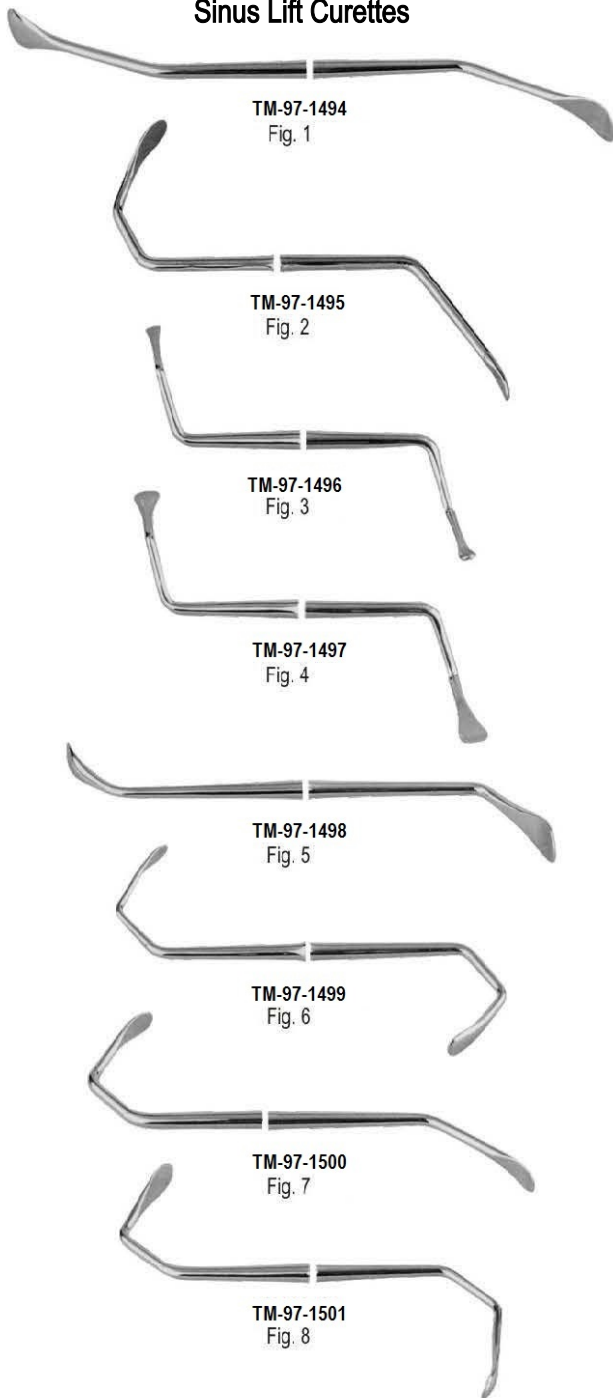
TM-96-1492
Manual Easy Bone Mill



TM-96-1493
Bone Craker Titanium



Sinus Lift Curettes



Sinus Lift Curettes Titanium Coated





Sinus Lift Curette

Sinus Lift Curette Titanium Coated



TM-98-1510
Fig. 1



TM-98-1518
Fig. 1



TM-98-1511
Fig. 2



TM-98-1519
Fig. 2



TM-98-1512
Fig. 3



TM-98-1520
Fig. 3



TM-98-1513
Fig. 4



TM-98-1521
Fig. 4



TM-98-1514
Fig. 5



TM-98-1522
Fig. 5



TM-98-1515
Fig. 6



TM-98-1523
Fig. 6



TM-98-1516
Fig. 7



TM-98-1524
Fig. 7

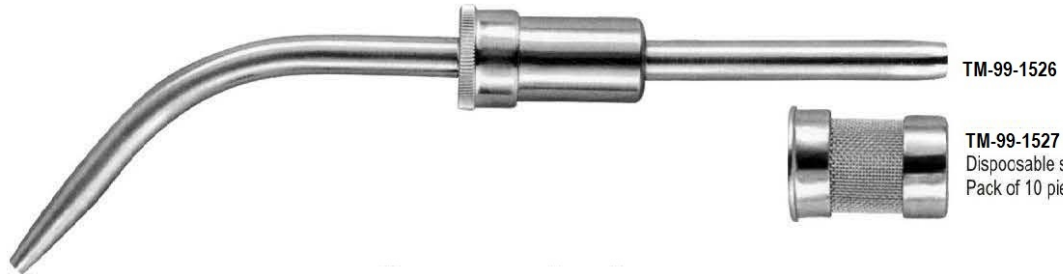


TM-98-1517
Fig. 8



TM-98-1525
Fig. 8

Bone Collector



TM-99-1526

TM-99-1527
Disposable stainless steel cartridge
Pack of 10 pieces



TM-99-1528 Applicator Titanium Coated



TM-99-1529 Applicator & compactor Titanium Coated

Compactors



TM-99-1530 Hollow Handle



TM-99-1531 Hollow Handle

Compactors Titanium Coated



TM-99-1532 Hollow Handle



TM-99-1533 Hollow Handle

Membrane placement instruments Titanium Coated



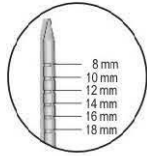
TM-99-1534



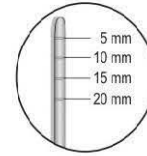
TM-99-1535
11 cm



Osteotomes



Dilator



Spreader

A-Form

D-Form
Convex Tips

Ø 2 mm

Ø 3 mm

Ø 3.3 mm

Ø 4 mm

Ø 3 mm

Ø 4 mm

Ø 5 mm



14.5 mm



TM-100-1536
14.5 cm



TM-100-1537
14.5 cm



TM-100-1538
14.5 cm



TM-100-1539
14.5 cm



TM-100-1540
14.5 cm



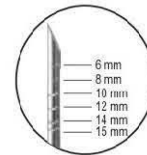
TM-100-1541
14.5 cm



TM-100-1542
14.5 cm



FREER Osteotomos



FREER Osteolemos

Ø 1.6 mm

Ø 1.9 mm

Ø 2.8 mm

Ø 3.1 mm

Ø 3.9 mm

Ø 3.0 mm

Ø 3.3 mm

Ø 4.0 mm



TM-100-1543



TM-100-1544



TM-100-1545



TM-100-1546



TM-100-1547



TM-100-1548

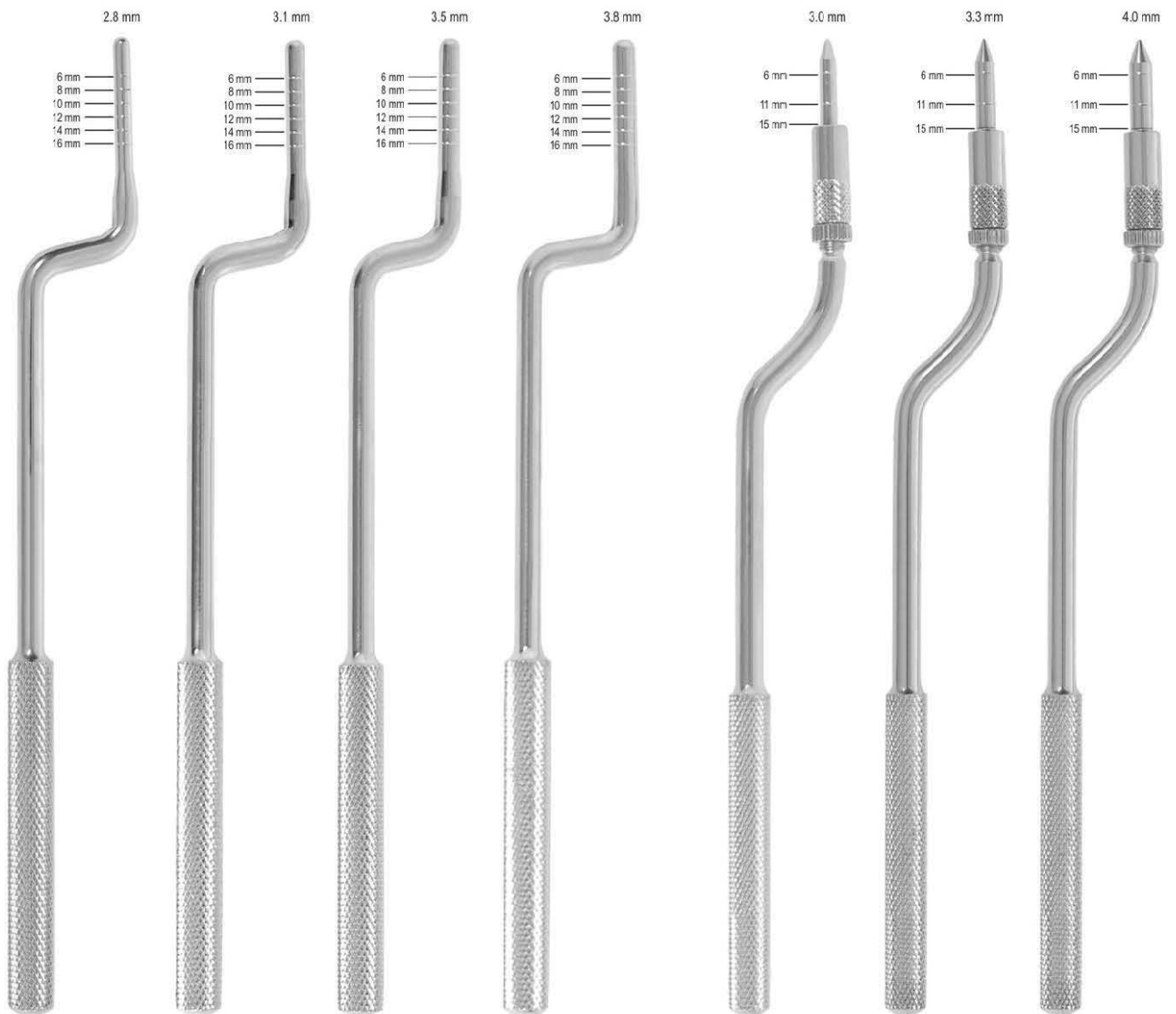


TM-100-1549



TM-100-1550









Osteotomes



TM-101-1551 Curved
TM-101-1552 Straight
TM-101-1553 Curved
TM-101-1554 Straight
TM-101-1555 Curved
TM-101-1556 Straight
TM-101-1557 Curved
TM-101-1558 Straight

TM-101-1559 Curved
TM-101-1560 Straight
TM-101-1561 Curved
TM-101-1562 Straight
TM-101-1563 Curved
TM-101-1564 Straight



- 
TM-102-1565
Interior 2 mm
Exterior 3 mm
- 
TM-102-1566
Interior 3 mm
Exterior 4 mm
- 
TM-102-1567
Interior 4 mm
Exterior 5 mm
- 
TM-102-1568
Interior 5 mm
Exterior 6 mm
- 
TM-102-1569
Interior 6 mm
Exterior 7 mm
- 
TM-102-1570
Interior 7 mm
Exterior 8 mm
- 
TM-102-1571
Interior 8 mm
Exterior 9 mm
- 
TM-102-1572
Interior 9 mm
Exterior 10 mm

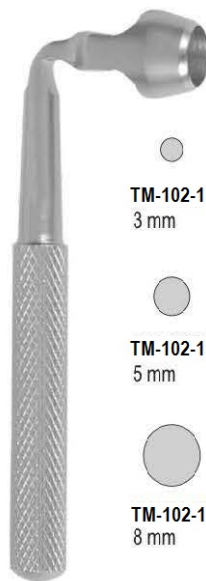




TM-102-1573
Trepine Drills Stand
Complete with drills



TM-102-1574
Trepine Drills Stand
Complete with drills





Tissue Punches



- 
TM-102-1575
3 mm
- 
TM-102-1576
4 mm
- 
TM-102-1577
5 mm
- 
TM-102-1578
8 mm

Keyes



- 
TM-102-1579
3 mm
- 
TM-102-1580
4 mm
- 
TM-102-1581
5 mm
- 
TM-102-1582
6 mm

Keyes

Bone Thickness Gauges



Fig. 1
Castroviejo
TM-103-1583



Fig. 2
Castroviejo
TM-103-1584



Fig. 3
Castroviejo
TM-103-1585

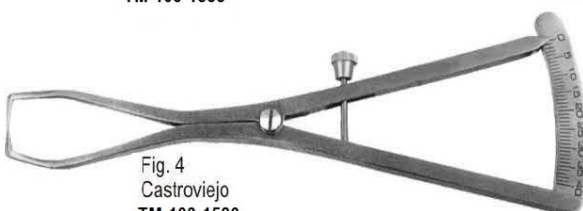
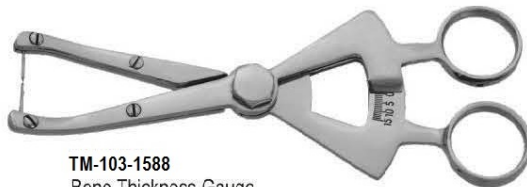


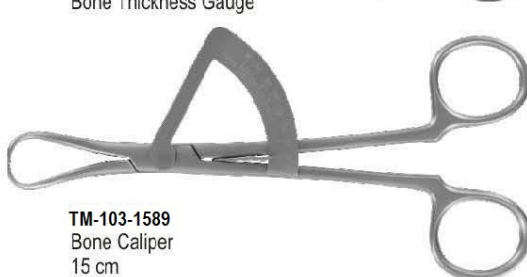
Fig. 4
Castroviejo
TM-103-1586



Fig. 5
Castroviejo
TM-103-1587



TM-103-1588
Bone Thickness Gauge



TM-103-1589
Bone Caliper
15 cm



TM-103-1590
Bone Sinus Rongeur
Titanium Coated
4 mm bite

Bone Injectors



Fig. 1
TM-103-1591

Fig. 2
TM-103-1592

Fig. 3
TM-103-1593

Fig. 4
TM-103-1594



Bone Black Clamps Titanium Coated



TM-103-1595
Posterior



TM-103-1596
Anterior



Depth measuring probes

TM-103-1597
Titanium tip, silicone handle & laser marked



Periotome Titanium Coated



Fig. 1 TM-104-1598

Periosteal Elevators Titanium Coated



Fig.1 TM-104-1600



Fig.2 TM-104-1601 Sharp-Blunt



Fig.1 TM-104-1602 Atraumatic papilla

Mallet



TM-104-1603
Partsch
Stainless Steel head
19 cm



TM-104-1604
Partsch
Lead filled head
19 cm



TM-104-1605
Mead 19 cm
TM-104-1606
Spare plastic disks, pair



TM-104-1607
18.5 cm
TM-104-1608
Spare plastic disks, pair



TM-104-1609
19 cm
TM-104-1610
Spare plastic disks, pair



TM-104-1611
20 cm
TM-104-1612
Spare plastic disks, pair

Periosteal



Fig.15 TM-105-1613 Freer



Fig.16 TM-105-1614 Freer

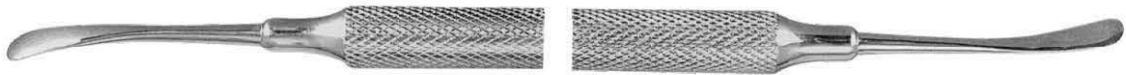


Fig.14 TM-105-1615 FGoldman-Fox



Fig.20 TM-105-1616 Hirschfield

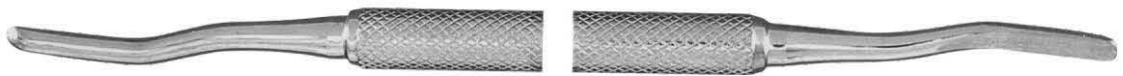


Fig.1 TM-105-1617 Hopkins

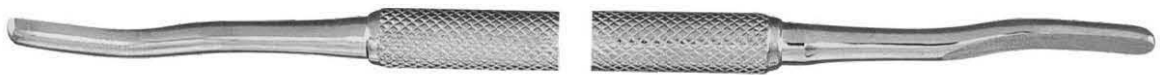


Fig.2 TM-105-1618 Hopkins



Fig.3 TM-105-1619 Mead/West

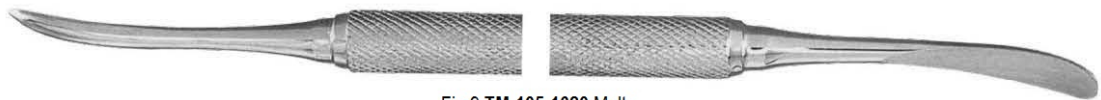


Fig.9 TM-105-1620 Molt



Fig.3 TM-105-1621 Prichard



Fig.9 TM-105-1622 Molt



Titanium Periosteal



Fig.1 TM-106-1623 Buser Blue



Fig.3 TM-106-1624 Prichard Blue

Implant periosteal



Fig.1 TM-106-1625 Buser



Fig.9A TM-106-1626 Allen



Fig.25 TM-106-1627 17 cm

Periodontal Curette



TM-106-1628
Gingivectomy Kirkland Hollow handle
Fig.15/16



TM-106-1629
Gingivectomy Orban Hollow handle
Fig.1/2



TM-106-1630
Gingivectomy Kirkland Solid handle
Fig.15/16



TM-106-1631
Gingivectomy Orban Solid handle
Fig.1/2



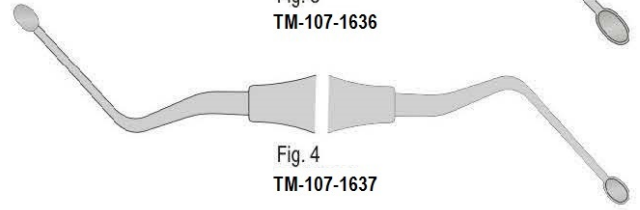
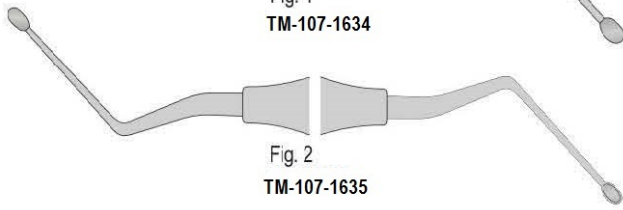
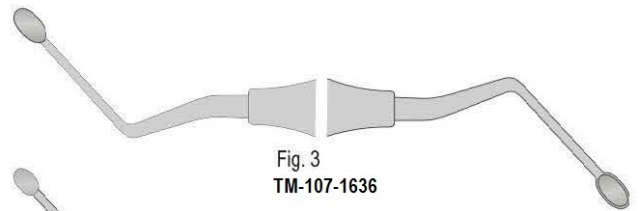
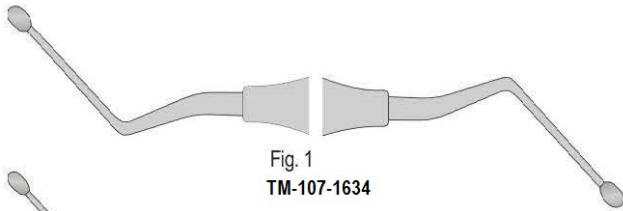
TM-106-1632
Gingivectomy Orban
Fig.1



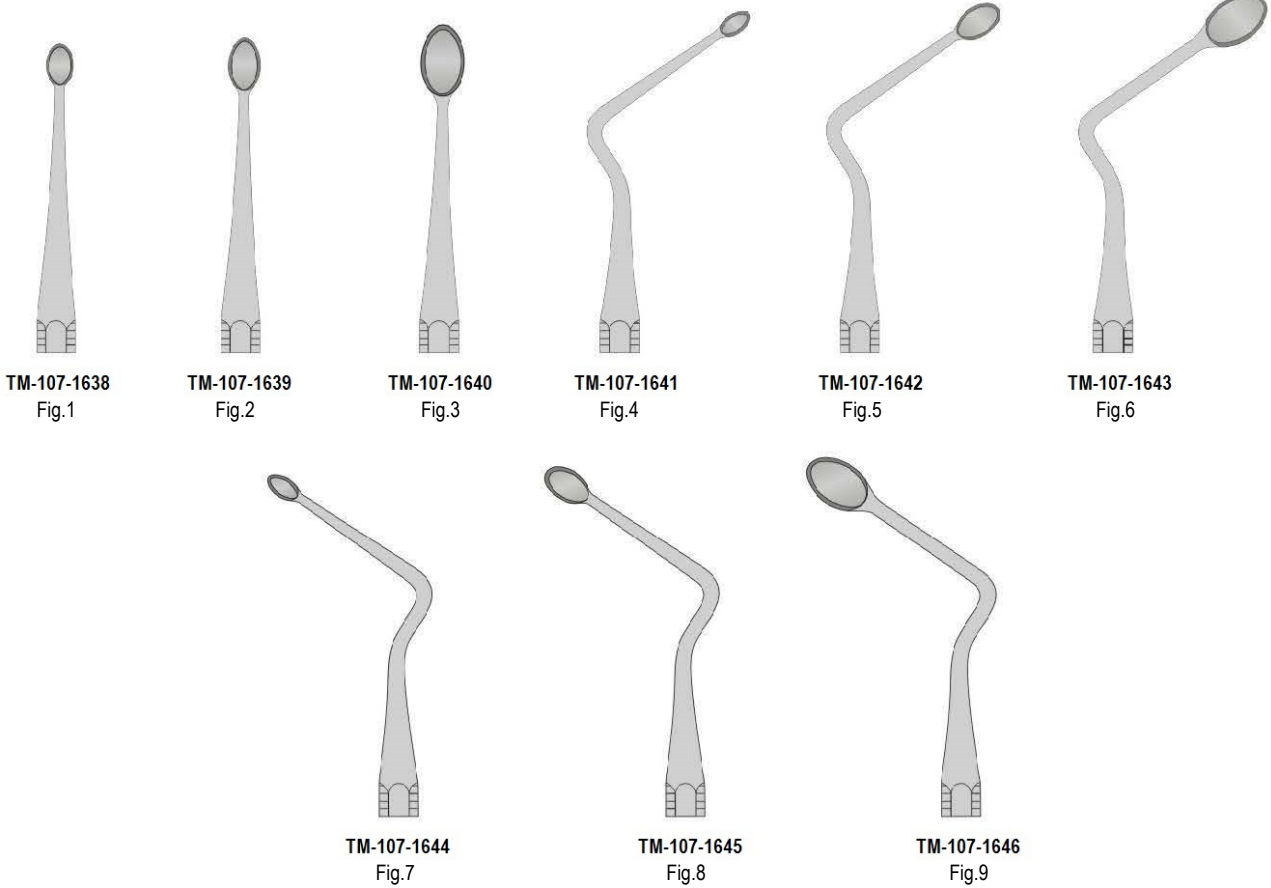
TM-106-1633
Gingivectomy Orban
Fig.2

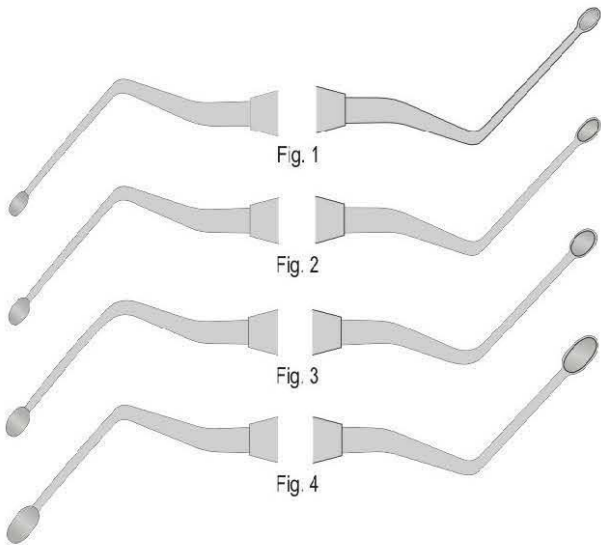
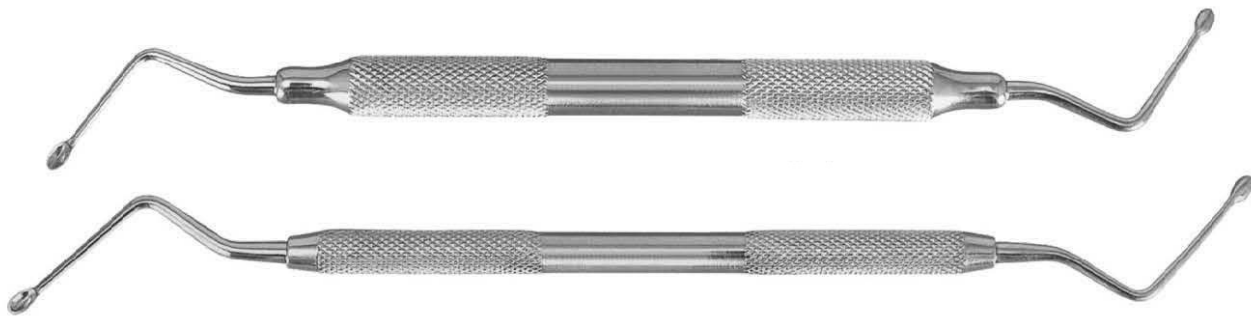
Bone Curette

Hemingway Hollow Handle

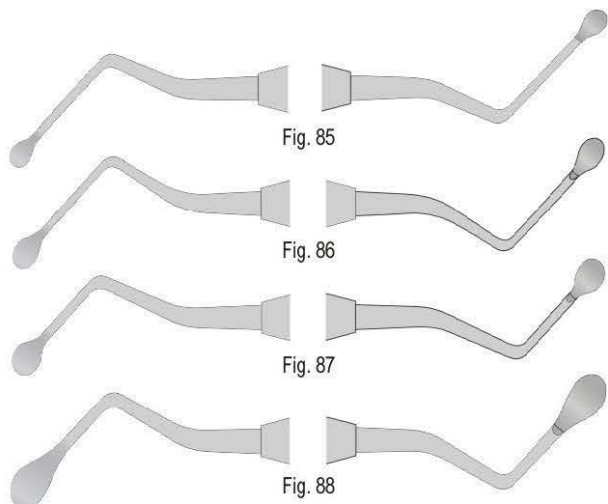
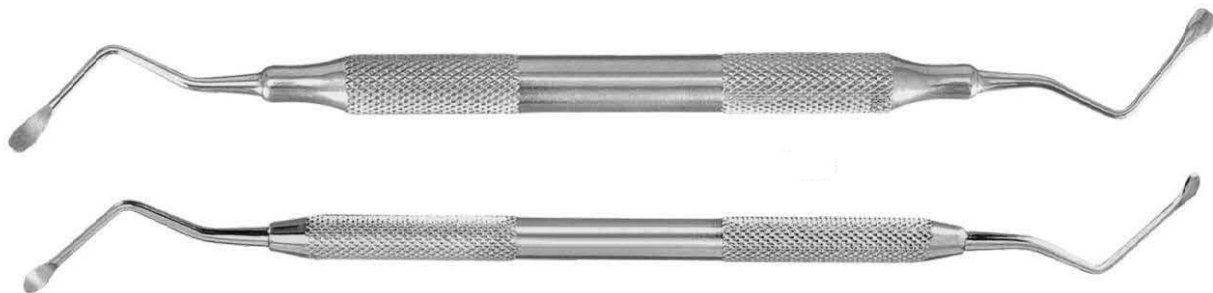


Hemingway Solid handle





| | Hemingway Solid handle | Hemingway Hollow handle |
|--------|---------------------------|----------------------------|
| Fig. 1 | TM-108-1647 | TM-108-1651 |
| Fig. 2 | TM-108-1648 | TM-108-1652 |
| Fig. 3 | TM-108-1649 | TM-108-1653 |
| Fig. 4 | TM-108-1650 | TM-108-1654 |



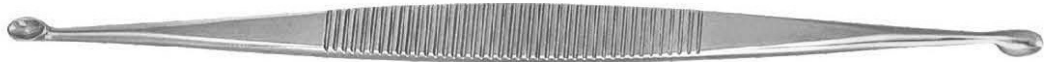
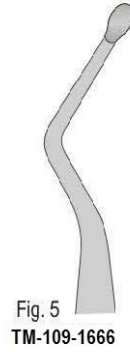
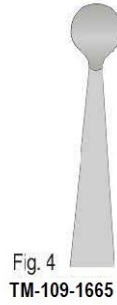
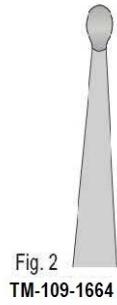
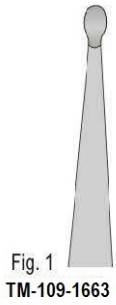
| | Lucas Solid handle | Lucas Hollow handle |
|---------|-----------------------|------------------------|
| Fig. 85 | TM-108-1655 | TM-108-1659 |
| Fig. 86 | TM-108-1656 | TM-108-1660 |
| Fig. 87 | TM-108-1657 | TM-108-1661 |
| Fig. 88 | TM-108-1658 | TM-108-1662 |

Bone Curette, Bone File/Rasp

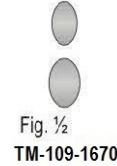
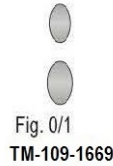
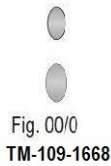
Bone Curette



Molt
16.5 cm



Williger
14 cm



Bone File/Rasp



Fig. 10
TM-109-1671





Hooks



TM-110-1677
15 cm

Kilner



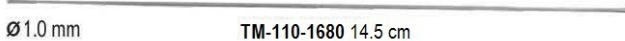
TM-110-1678
18 cm

Gillies



TM-110-1679
18 cm

Surgical Probe



Ø 1.0 mm

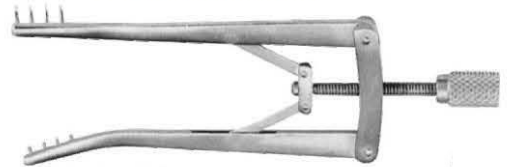
TM-110-1680 14.5 cm



Ø 2.0 mm

TM-110-1681 14.5 cm

Self-Retaining Retractor



TM-110-1682 Self-Retaining Sharp Alm 7 cm
TM-110-1683 Self-Retaining Blunt Alm 7 cm



TM-110-1684 Self-Retaining Sharp Weitlaner 13 cm
TM-110-1685 Self-Retaining Blunt Weitlaner 13 cm

Dressing Forceps Tweezers



TM-110-1686
16 cm
Suture

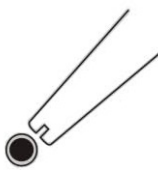
Suction Tubes



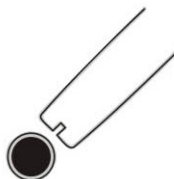
TM-110-1687
Ø 1.5mm



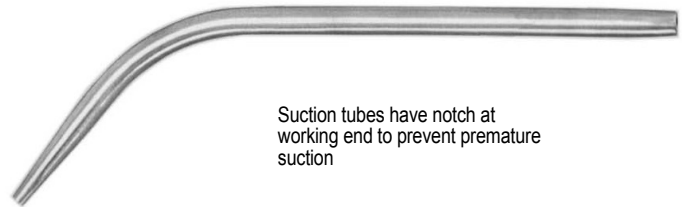
TM-110-1688
Ø 4mm



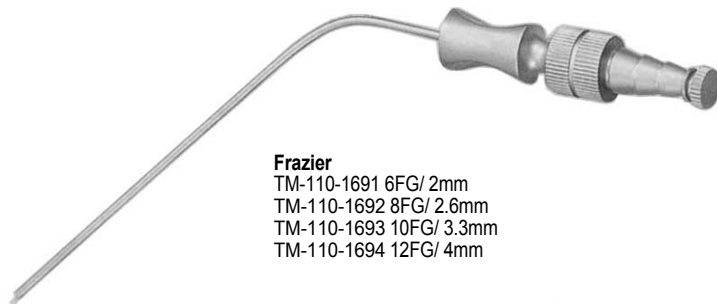
TM-110-1689
Ø 3mm



TM-110-1690
Ø 5mm



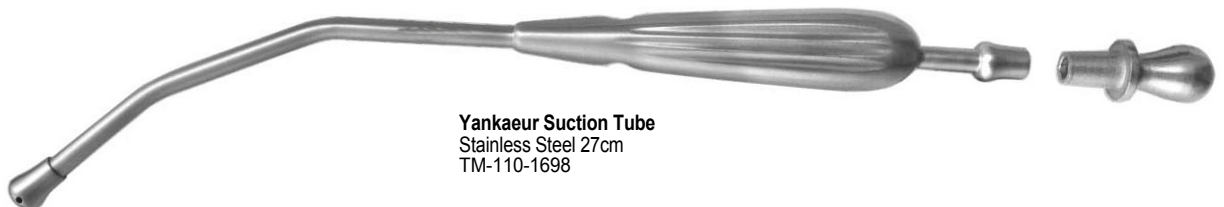
Suction tubes have notch at working end to prevent premature suction



Frazier
TM-110-1691 6FG/ 2mm
TM-110-1692 8FG/ 2.6mm
TM-110-1693 10FG/ 3.3mm
TM-110-1694 12FG/ 4mm



Ladmore
TM-110-1695 Small
TM-110-1697 Large



Yankauer Suction Tube
Stainless Steel 27cm
TM-110-1698



Page 111-115

- DENTAL ASPIRATION SYRINGE



TM-111-1700
Type - A
Metric Thread
1.8 ml



TM-111-1701
Type - C
Metric Thread
1.8 ml

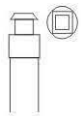
Manual



TM-111-1702
Type - A
Metric Thread
1.8 ml



TM-111-1703
Type - C
Metric Thread
1.8 ml



TM-111-1704
P - Ject
Metric Thread
1.8 ml



TM-111-1705
Type - A
Metric Thread
1.8 ml

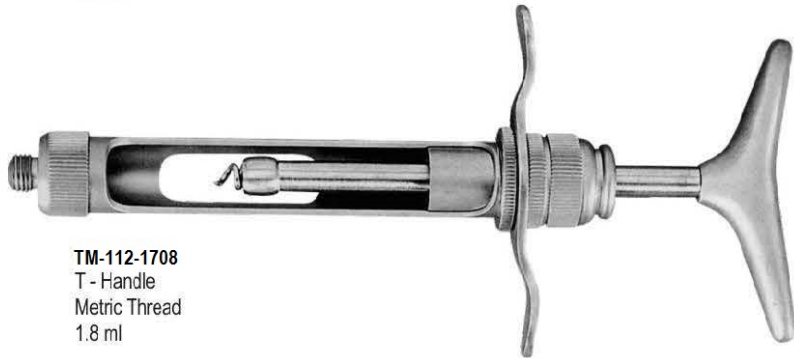


TM-111-1706
Euro
Metric Thread
1.8 ml

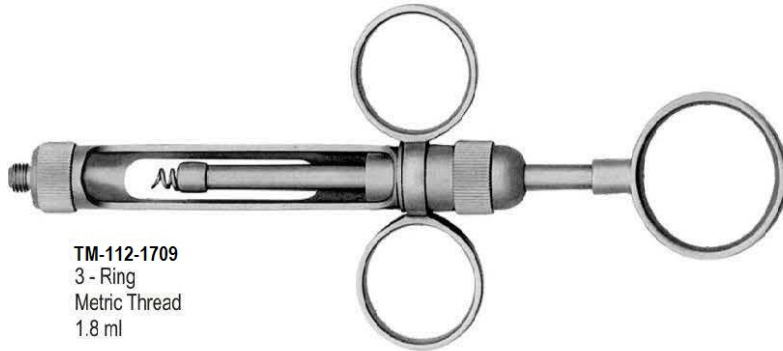
Manual



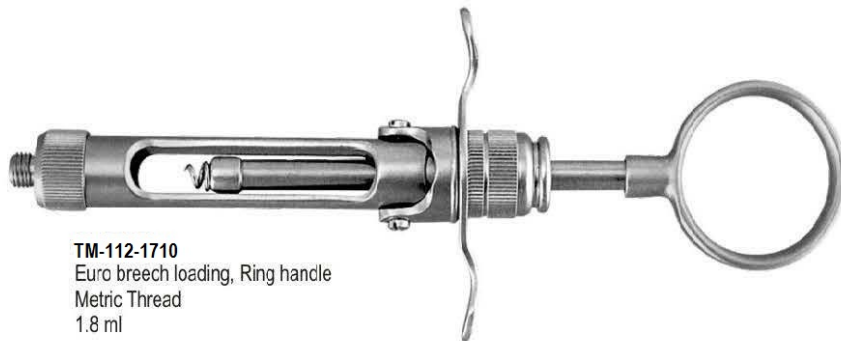
TM-112-1707
Euro
Metric Thread
1.8 ml



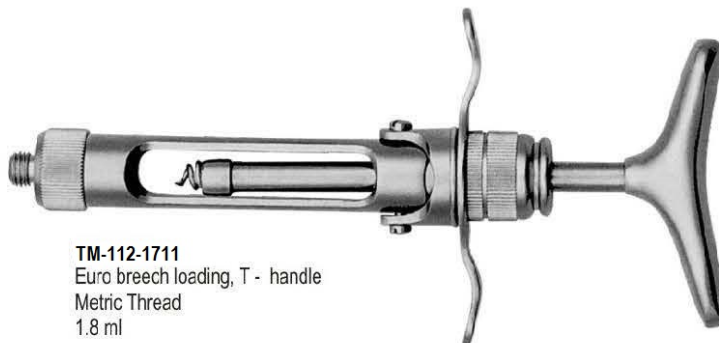
TM-112-1708
T - Handle
Metric Thread
1.8 ml



TM-112-1709
3 - Ring
Metric Thread
1.8 ml



TM-112-1710
Euro breech loading, Ring handle
Metric Thread
1.8 ml



TM-112-1711
Euro breech loading, T - handle
Metric Thread
1.8 ml



Manual



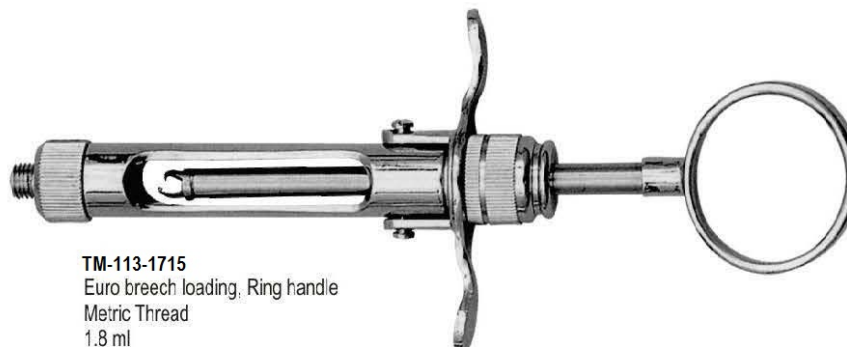
TM-113-1712
Euro
Metric Thread
1.8 ml



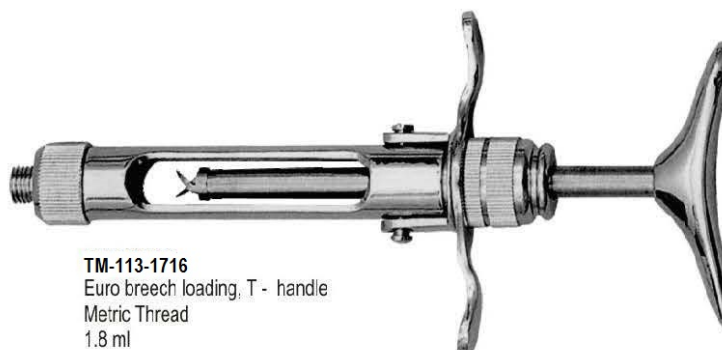
TM-113-1713
3 - Ring
Metric Thread
1.8 ml



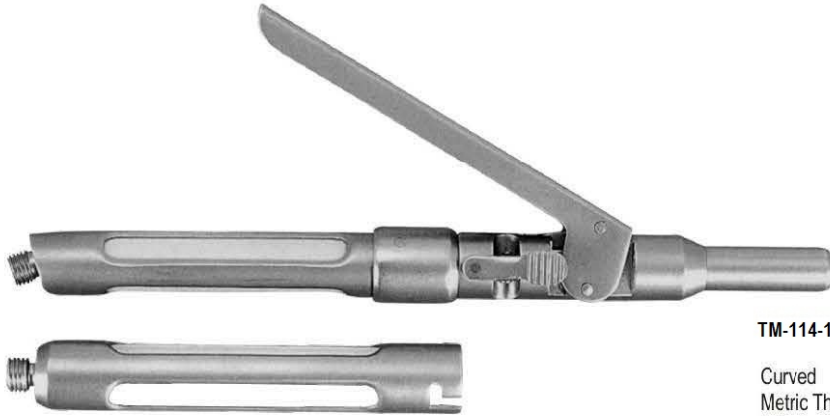
TM-113-1714
2 - Ring
Metric Thread
1.8 ml



TM-113-1715
Euro breech loading, Ring handle
Metric Thread
1.8 ml



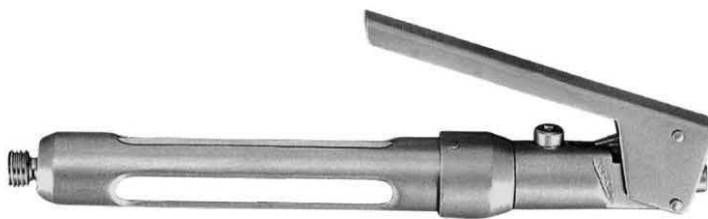
TM-113-1716
Euro breech loading, T - handle
Metric Thread
1.8 ml



TM-114-1717
Curved
Metric Thread
1.8 ml



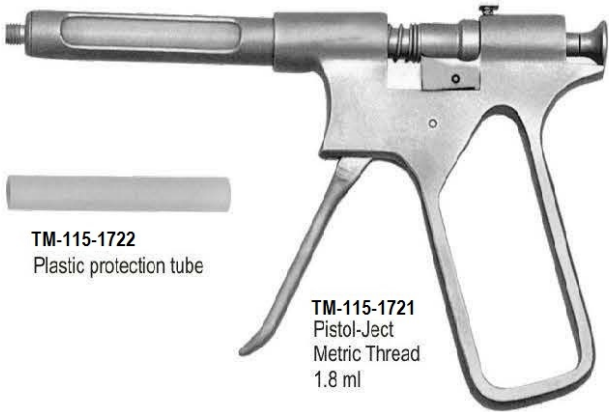
TM-114-1718
Curved
Metric Thread
1.8 ml



TM-114-1719
Straight
Metric Thread
1.8 ml



TM-114-1720
Swedish Type
Metric Thread
1.8 ml



TM-115-1722
Plastic protection tube

TM-115-1721
Pistol-Ject
Metric Thread
1.8 ml



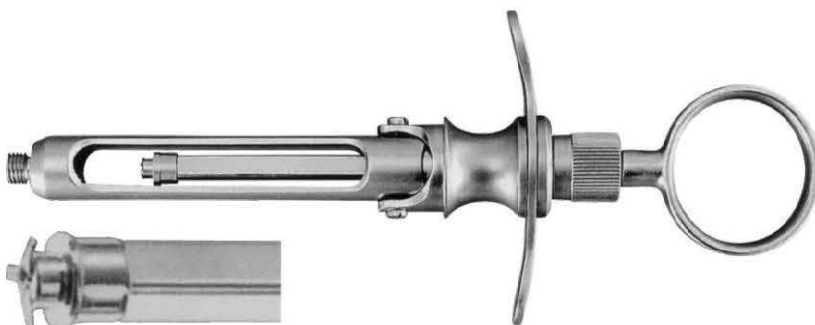
TM-115-1723
Pistol-Ject
Metric Thread
1.8 ml



TM-115-1724
Disc System
Metric Thread
1.8 ml



TM-115-1725
Projection System
Metric Thread
1.8 ml



TM-115-1726
Trio
Metric Thread
1.8 ml



Page 116–129

- RUBBER DAM CLAMP FORCEPS
- RUBBER DAM CLAMP
- DENTAL MAXTIX RETAINER
- DENTAL SCALER
- ORTHODONTIC GAUGE
- DENTAL DRESSING FORCEPS
- DRESSING FORCEPS TWEEZERS
- DENTAL CROWN REMOVERS
- DENTAL SCISSORS
- BONE SAW
- MALLET



TM-116-1730
Brewer



TM-116-1731
Ivory



TM-116-1732
Ivory



TM-116-1733
Matrix Plier
17 cm



TM-116-1734
Stokes



TM-116-1735
Stokes / Palmer



TM-116-1736
Ivory

Punch

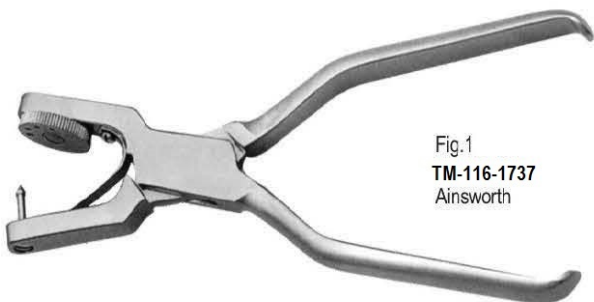


Fig.1
TM-116-1737
Ainsworth



Fig.2
TM-116-1738
Ainsworth

Rubber Dam Clamp

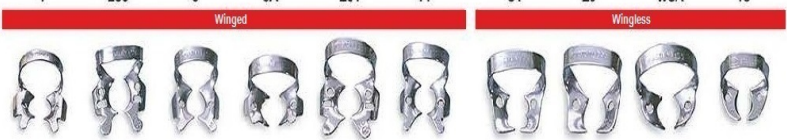
TM-117-211 211 TM-117-2A 2A TM-117-212 212 TM-117-29 29



TM-117-51 51 TM-117-31 31 TM-117-30 30 TM-117-25 25 TM-117-W8A W8A TM-117-18 18



TM-117-4 4 TM-117-205 205 TM-117-5 5 TM-117-8A 8A TM-117-201 201 TM-117-14 14 TM-117-51 51 TM-117-26 26 TM-117-W8A W8A TM-117-18 18



TM-117-1 1 TM-117-1A 1A TM-117-207 207 TM-117-208 208 TM-117-2A 2A TM-117-22 22 TM-117-27 27 TM-117-W2A W2A



TM-117-11 11 TM-117-10 10 TM-117-3 3 TM-117-203 203 TM-117-204 204 TM-117-202 202 TM-117-201 201



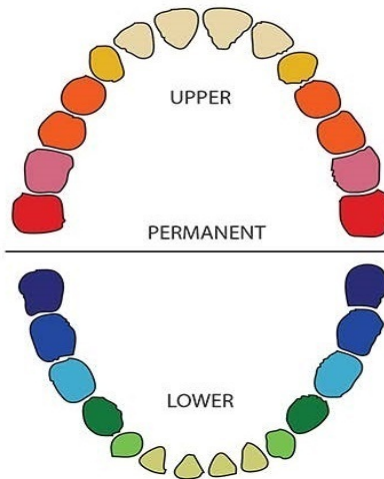
TM-117-211 211 TM-117-2 2 TM-117-22 22



TM-117-211 211 TM-117-210 210 TM-117-90N 90N



TM-117-6 6 TM-117-9 9



TM-117-211 211 TM-117-212 212



TM-117-208 208 TM-117-207 207 TM-117-206 206 TM-117-22 22 TM-117-27 27 TM-117-29 29



TM-117-W3 W3 TM-117-31 31 TM-117-30 30 TM-117-28 28 TM-117-25 25 TM-117-15 15



TM-117-205 205 TM-117-5 5 TM-117-8A 8A TM-117-201 201 TM-117-14A 14A TM-117-4 4 TM-117-8 8 TM-117-28 28 TM-117-24 24



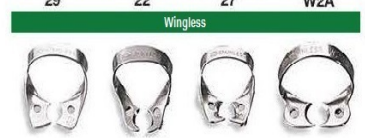
TM-117-207 207 TM-117-209 209 TM-117-0 0 TM-117-00 00 TM-117-2A 2A TM-117-1 1 TM-117-1A 1A

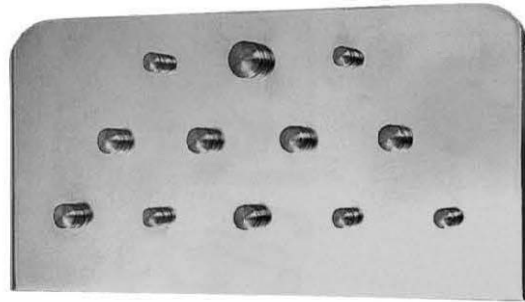


TM-117-200 200 TM-117-202 202 TM-117-14 14 TM-117-56 56 TM-117-7 7 TM-117-7A 7A TM-117-14A 14A TM-117-56A 56A



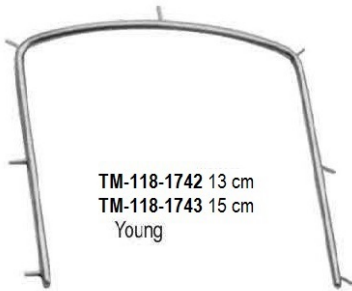
TM-117-29 29 TM-117-22 22 TM-117-27 27 TM-117-W2A W2A



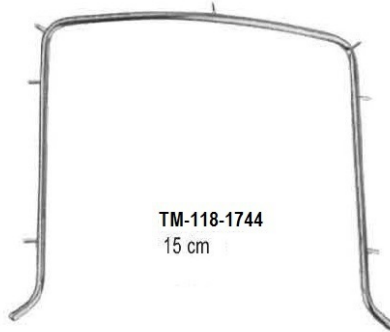


TM-118-1741
Tray set of 12

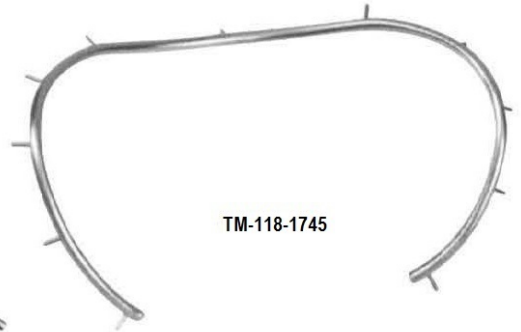
Frames



TM-118-1742 13 cm
TM-118-1743 15 cm
Young



TM-118-1744
15 cm



TM-118-1745

Matrix Retainers



TM-118-1746
cheek protector
5 mm



Fig. 8
TM-118-1747
Ivory
5 mm



Fig. 8
TM-118-1748
Ivory
6 mm



Fig. 8
TM-118-1749
Ivory
7 mm



TM-118-1750
Tofflemire Junior



TM-118-1751
Tofflemire senior



TM-118-1752
Tofflemire universal



TM-118-1753
Nystrom
Left



TM-118-1754
Nystrom
Right



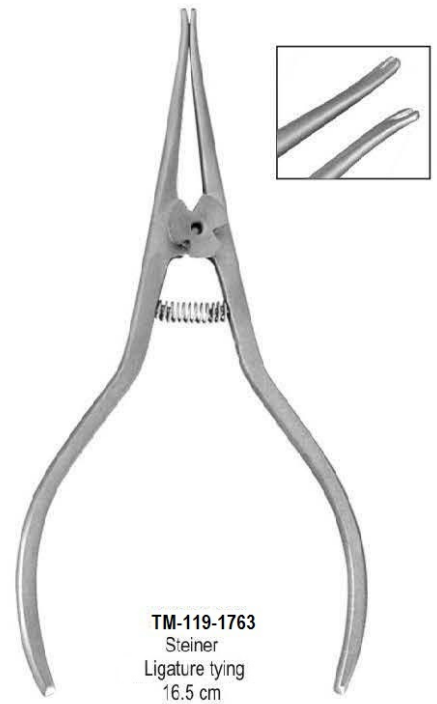
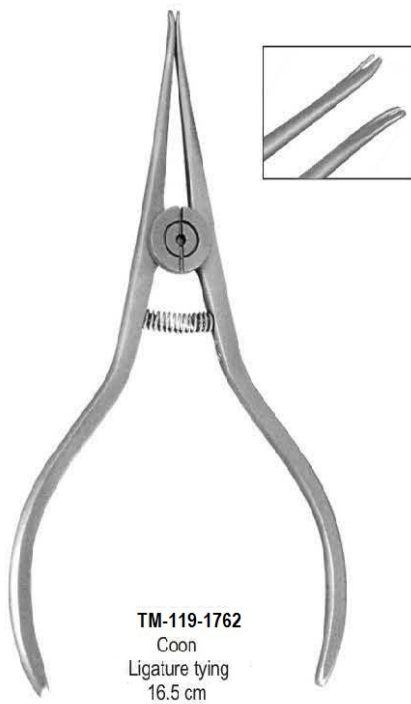
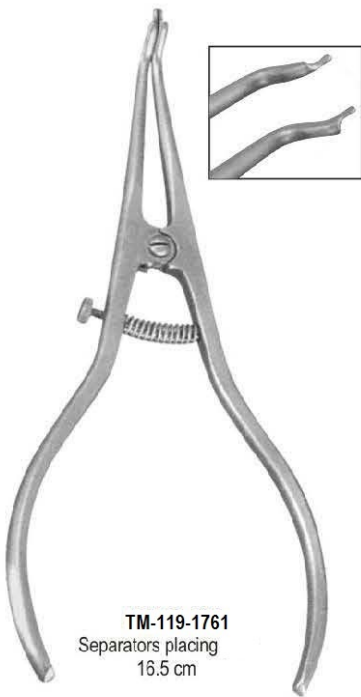
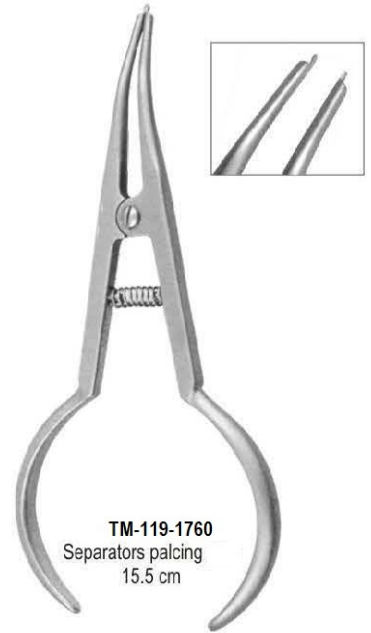
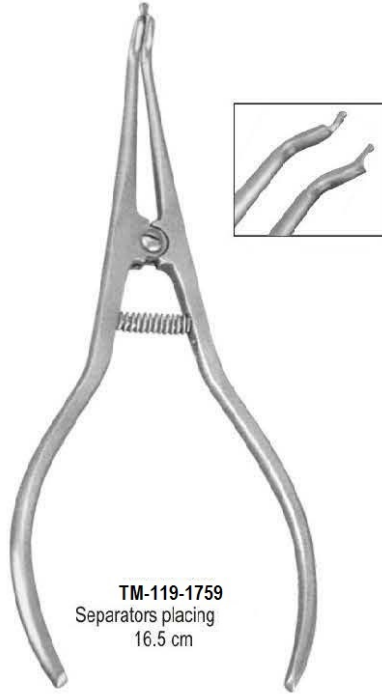
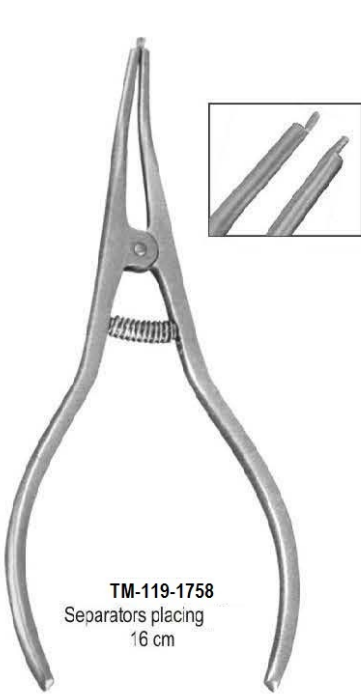
Fig. 12A
TM-118-1755
Ivory



Fig. 12
TM-118-1756
Ivory

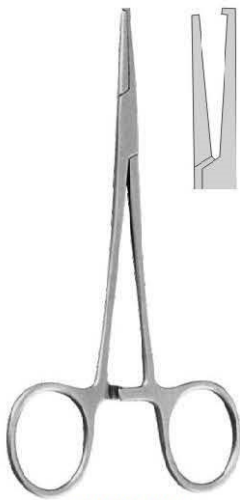


TM-118-1757
Strip clamp
straight





Elastic Ligature Placing



TM-120-1764
Straight 12 cm



TM-120-1765
Curved 12 cm



TM-120-1766
14 cm



TM-120-1767
12 cm



TM-120-1768
14 cm



TM-120-1769
Elastomeric ligature
removing tweezer



Ligature
14 cm



Fig.1
TM-120-1770



Fig.2
TM-120-1771



Fig.3
TM-120-1772



Smaha
Ligature
14 cm



TM-120-1773
Straight



TM-120-1774
Curved



TM-120-1775
Ligature
14 cm



TC Insert

Basic Examination Set of 4 Pieces



TM-121-1776

Elastic Ligature Applicators



TM-121-1777

Elastomeric Ligature Removing Instruments



TM-121-1778



TM-121-1779

Ligature Tuckers Hollow Handle



TM-121-1780



TM-121-1781



TM-121-1782

Ligature Tuckers Solid Handle



TM-121-1783



TM-121-1784



TM-121-1785



Distal End Bending Instruments



TM-122-1786
For wire upto .22" (0.56 mm)

TM-122-1787
For wire upto .30" (0.76 mm)



TM-122-1788
For wire upto .22" (0.56 mm) Green

TM-122-1789
For wire upto .30" (0.76 mm) Green



Orange TM-122-1790



TM-122-1791
NiTi Ice Instrument 11.5 cm

Adhesive Removers



TM-122-1792 TM-122-1793
Yellow



Bracket Placer for Posterior Teeth



TM-122-1794

Bracket Positioning Gauges



TM-122-1795 For .018" slot brackets



TM-122-1796 For .022" slot brackets

Dental Dressing Forceps



TM-122-1798 13.5 cm
Bracket Placing



TM-122-1799 13.5 cm
Bracket Placing



TM-122-1800 11 cm
Bracket Placing

Tweezers



TM-122-1801 13.5 cm
Bracket with Slot Aligner

Fig. 1



TM-122-1802 13.5 cm
Bracket with Slot Aligner

Fig. 2



TM-122-1803 13.5 cm
Bracket with Slot Aligner

Fig. 3



TM-122-1797
Boone
Universal

Orthodontic Gauge , Dental Dressing Forceps



TM-123-1804
Band Seater
15 cm



TM-123-1805
Mershon band pusher
14 cm



TM-123-1806
Band seating

Scaler & band pushing Instruments



TM-123-1807



TM-123-1808
Brown

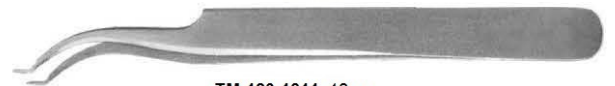
Dental Dressing Forceps



TM-123-1809 12.5 cm

TM-123-1810 13.5 cm

Reverse action buccal tube

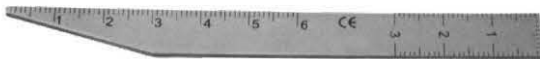


TM-123-1811 12 cm

TM-123-1812 13.5 cm

Buccal tube Keat

Measuring Instruments



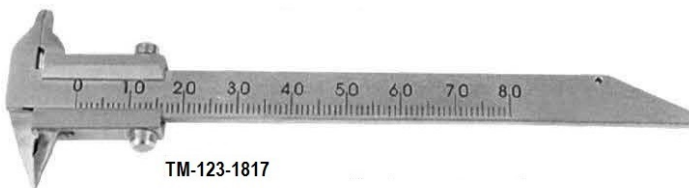
Bernklau
TM-123-1813



Ruler stainless steel
TM-123-1814 15 cm / 6"
TM-123-1815 30 cm / 12"



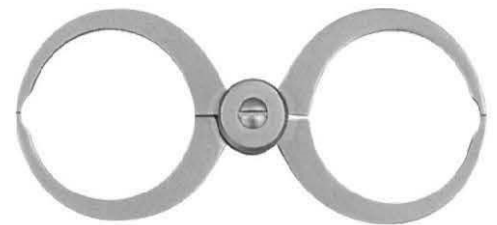
Beerendonk
TM-123-1816



TM-123-1817



TM-123-1818
Movable Heads Bracket Positioning Gauge



Orthodontic bow compass
TM-123-1819

Turrets

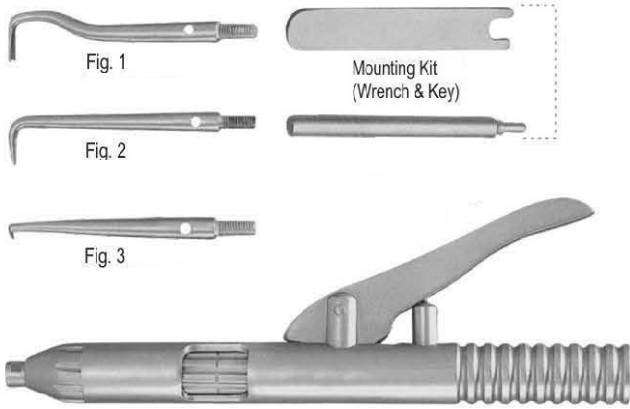
For forming archwires, without torque



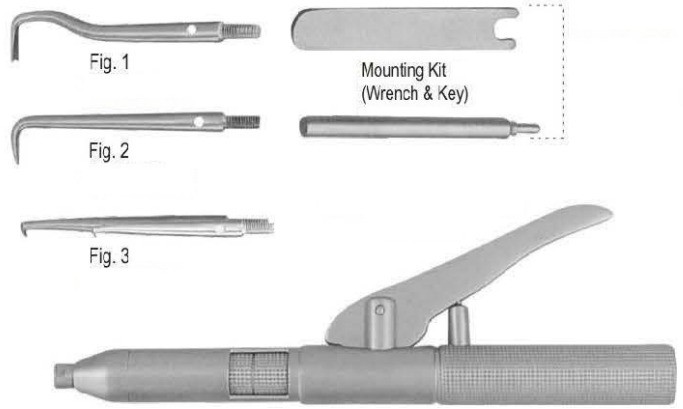
TM-123-1820



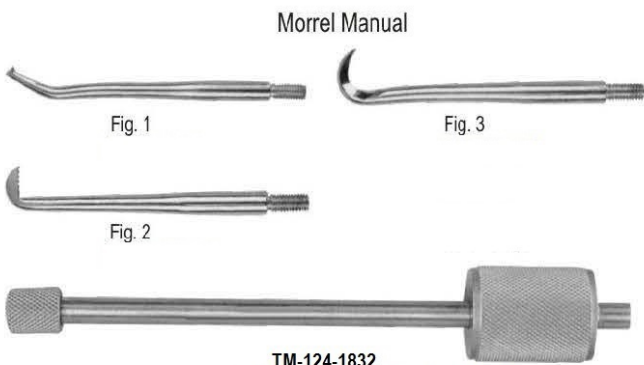
TM-123-1821



TM-124-1822
Automatic ,Mounting Kit (Wrench & Key), 3 Tips Fig1, Fig 2, Fig 3



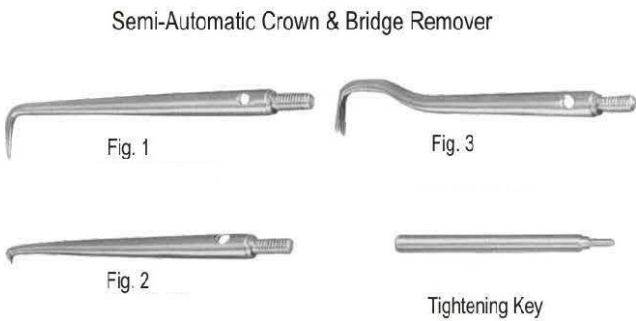
TM-124-1827
Automatic ,Mounting Kit (Wrench & Key), 3 Tips Fig1, Fig 2, Fig 3



TM-124-1832
Complete with Tips 3 Fig 1, Fig 2, Fig 3



TM-124-1836
Complete with Tips 3 Fig 1, Fig 2, Fig 3



TM-124-1840
Complete With 3 Tips Fig1, Fig 2, Fig 3 & Tightening key



Dressing Forceps Tweezers



TM-124-1845
Miller
15 cm

TM-124-1846
Miller
15 cm

TM-124-1847
Heights
15 cm

For Articulating Paper

manual double ended



Fig. 1



Fig. 2

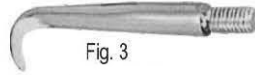
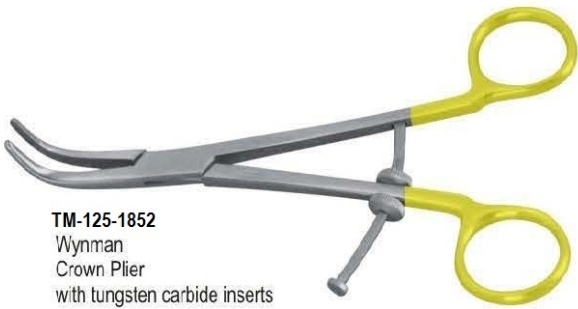


Fig. 3



TM-125-1848
Complete with 3 Tips Fig1, Fig 2, Fig 3



TM-125-1852
Wynman
Crown Plier
with tungsten carbide inserts



TM-125-1853
Furrer Crown Plier
16 cm



TM-125-1854
Crown spreader



Fig. 3
TM-125-1855
Crown Spreader



Crown Spreader



Fig. 0
TM-125-1856



Fig. 1
TM-125-1857



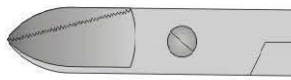
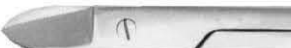
Fig. 2
TM-125-1858



Scissors

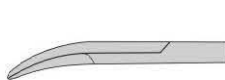


TM-126-1859
Straight



TM-126-1860
Curved

Bee Bee
10.5 cm



TM-126-1861
Curved



TM-126-1862
Straight

Bee Bee
10.5 cm



TM-126-1863
Wire Cutting Scissor
serrated 12 cm



TM-126-1864
Wire Cutting Scissor TC
serrated 12 cm

Crown Remover



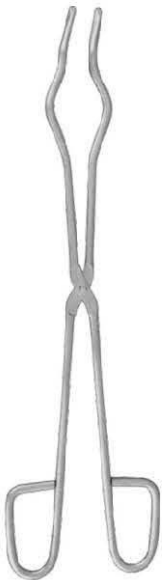
TM-126-1865
Straight



TM-126-1866
Curved

Crown Grippers
15 cm

Furnace Tongs



TM-127-1867
31 cm



TM-127-1868
40 cm



TM-127-1869
56 cm



TM-127-1871 20 cm Straight
TM-127-1872 20 cm Curved
Plaster Cutter

Calipers



Fig.1
TM-127-1872
Boley
Measuring range
0-100 mm



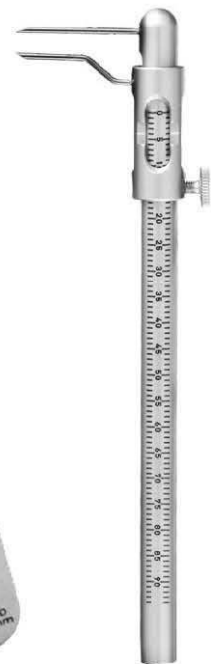
Fig.2
TM-127-1873
Boley
Measuring range
0-100 mm



TM-127-1874
Iwanson for Wax
Measuring range
0-10 mm



TM-127-1875
Iwanson for Metal
Measuring range
0-10 mm



TM-127-1876
Micro Boley Gauge



Modeling saw & blades



TM-128-1877

Fret saw & blades



TM-128-1883



TM-128-1878
0.25 x 3 mm Pack of 12 pcs



TM-128-1879
0.25 x 5 mm Pack of 12 pcs



TM-128-1880
0.12 x 5 mm Pack of 12 pcs

Mallet



Fig.1
TM-128-1885
Riveting Mallet
22 cm



Fig.2
TM-128-1886
Riveting Mallet
22 cm

Dental Dressing Forceps



TM-128-1881
Soldering Straight
Str 16 cm



TM-128-1882
Soldering Curved
Cvd 16 cm



TM-128-1887
Anvil
Carbon Steel



Orthodontic Gauge

Napkin Holder



Fig. 1
TM-129-1888
Ball chain

Napkin Holder



TM-129-1889
Plastic chain

X-Ray holders



Fig. 1
TM-129-1890



Fig. 6
TM-129-1891
6 Clips



Fig. 10
TM-129-1892
10 Clips

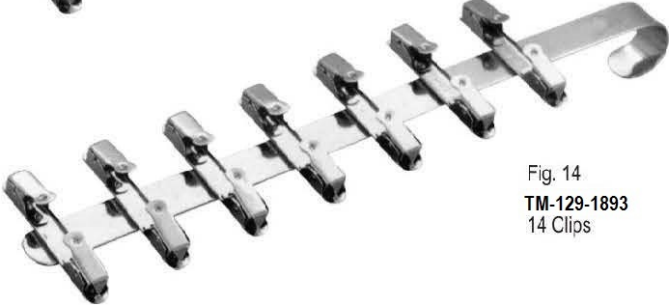


Fig. 14
TM-129-1893
14 Clips

Page 130-131

○ DENTAL ARTICULATOR



TM-130-1894
 Articulator ASA W/out Bearing Rod
 Anatomical Articulator With Incisive
 Pin, 4 Mounting Plates And Supporting
 Back-pin. Available In Assorted Colors



TM-130-1895
 ASA Articulator With Lateral Moment.
 Made Of Aluminum Die Casting With
 2 Mounting Plates. Also Available In
 Vibratory Polished Process & Assorted colors



TM-130-1896
 Keystone Deluxe Magnetic Denture
 Articulator With Plates, Interchangeable,
 Incisal Pin Included. Magnetic Split Casting
 Ensures Easy & Exact Setting, Lateral
 Excursions



TM-130-1897
 Keystone Deluxe Universal Type-A Articulator.
 Interchangeable, Included Incisal Pin, Lateral
 Excursions



TM-130-1898
 Anatomical Articulator Universal, Realized
 For Easy Visibility To The Lingual Surface
 & For A Perfect Stability Also In Reserved
 Position. Also available in Assorted Colors



TM-130-1899
 Chromium Plated Fork
 Fork Crowned Bridge Nickel
 Chromium Plated Articulator



TM-131-1900
Full Arch Hinged Articulator
Chromium Plated Hinge Articulator
For Mounting Full Arch Cases. Low
Back. Gypsum-free Articulation Enables
Clean & Accurate Mounting & Dismounting
In 30 Seconds



TM-131-1901
Ray Foster 57 Chrome Articulator
Chrome Brass Hinge Crowned Bridge
Articulator For Mounting Quadrant Cases.
Crown & Bridge Articulator Is Popular Ray
Foster # 57 Design, Eliminates The Need
To Break Off Models



TM-131-1902
Occlusor, Wire Articulator, Available
In 2 Sizes, Small & Large



TM-131-1903
Professional Occlusor, Vibratory
Polished Articulator.



TM-131-1904
Dental Articulator 2x-cresant Brand
Full Denture Chromium Plated Articulator.
Provides Additional Vertical Dimension For
Acceptance Of Higher Models. 49 Wide At
The Joint & Has A Vertical Span Between
Parallel Bows Of 25/8"



TM-131-1905
Hinge Articulator Full Arch
Plaine Line Nickle Chromium
Plated Articulator



TM-131-1906
Magic Art-I Articulator Lightweight



TM-131-1907
Mortimer-I Oculader Articulator

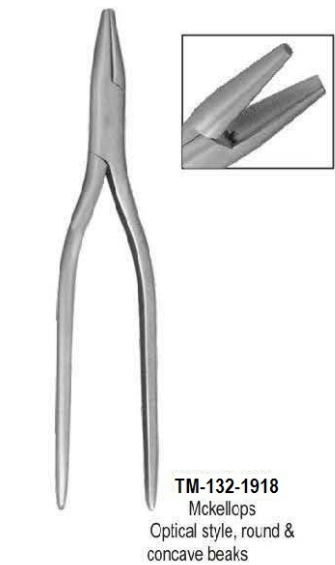
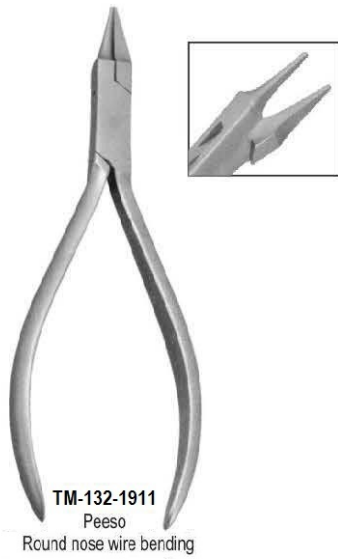
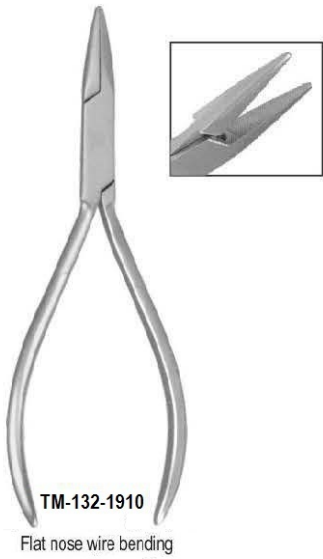


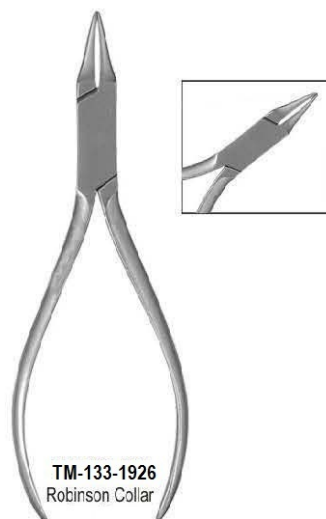
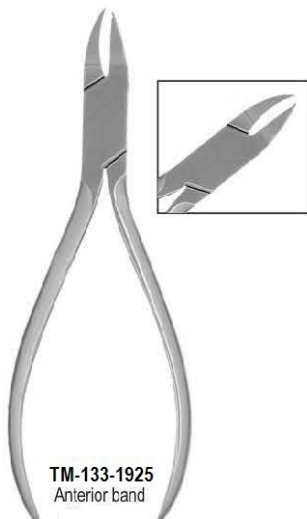
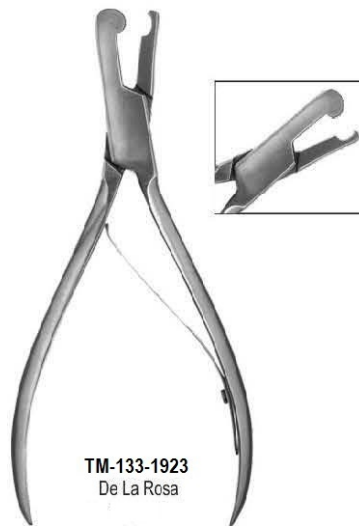
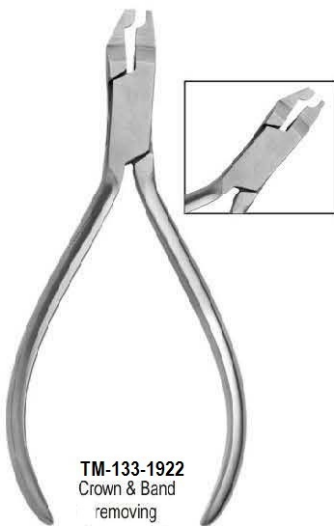
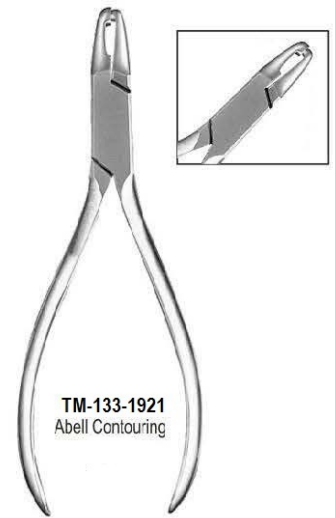
TM-131-1908
Mortimer-II Oculader Articulator

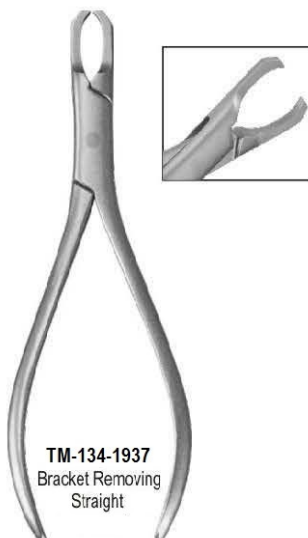
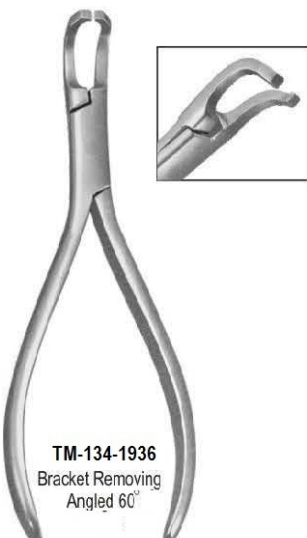


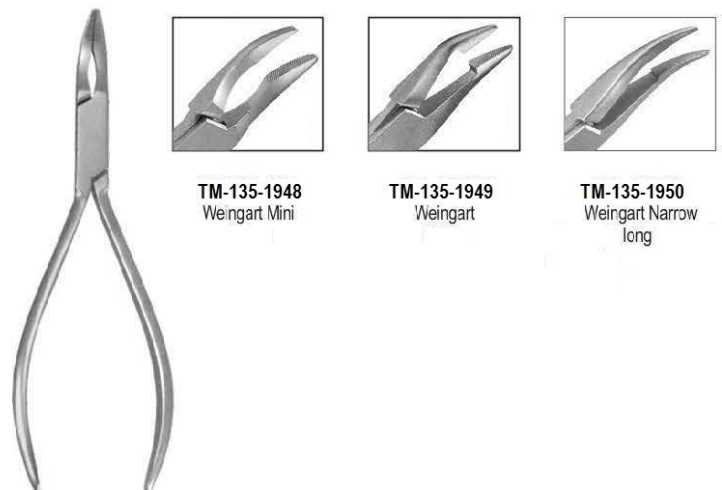
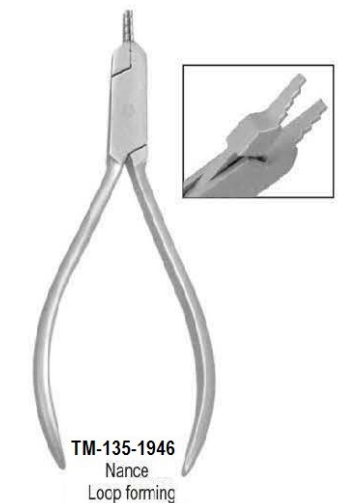
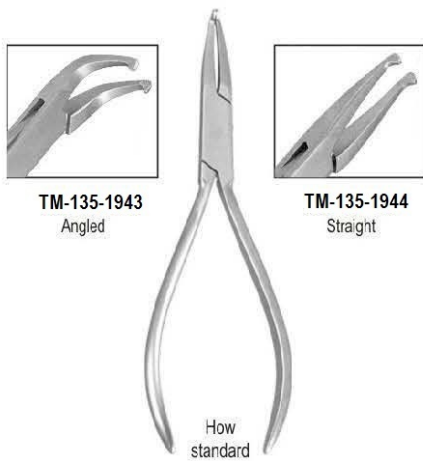
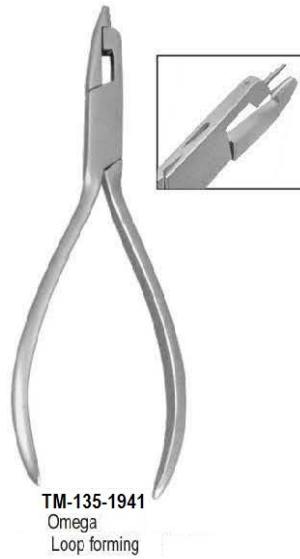
Page 132–149

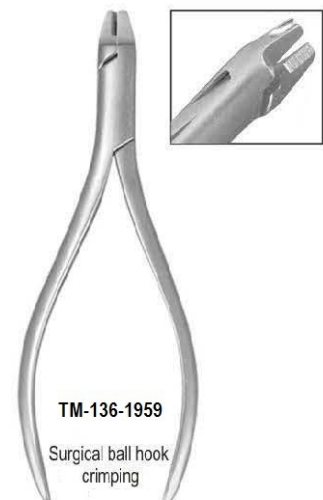
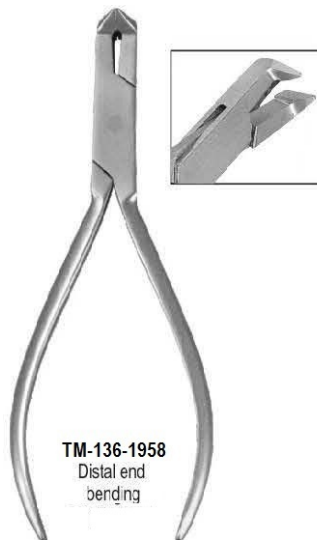
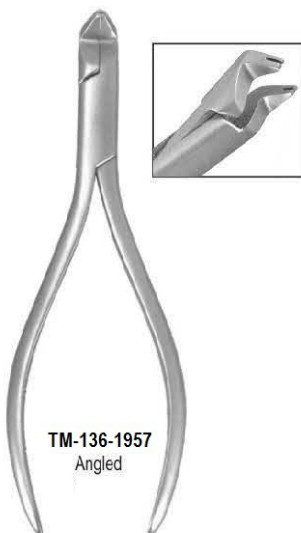
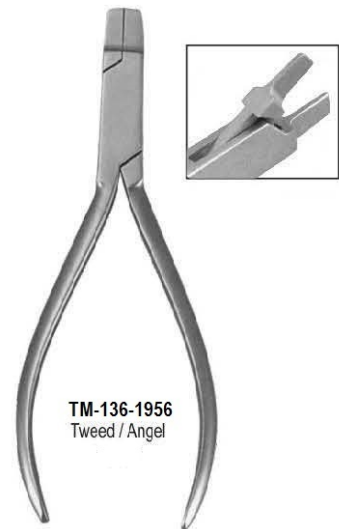
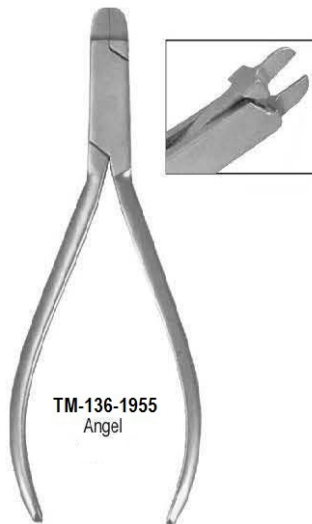
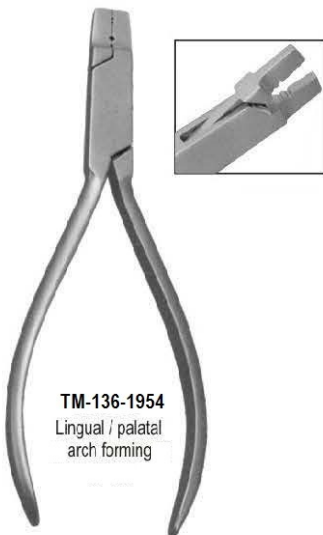
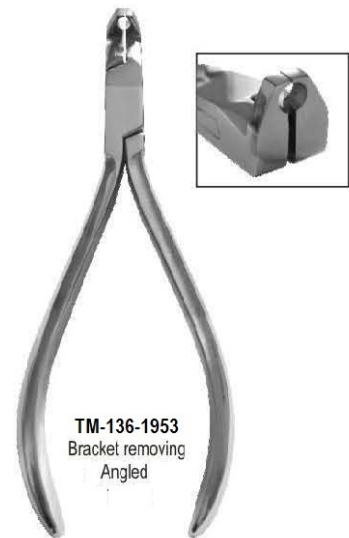
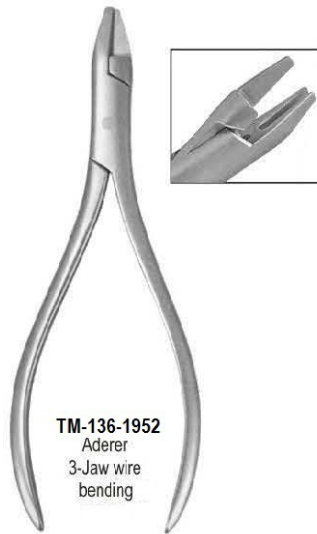
- ORTHODONTIC PLIRES
- BONE CUTTER
- DENTAL RONGEURS













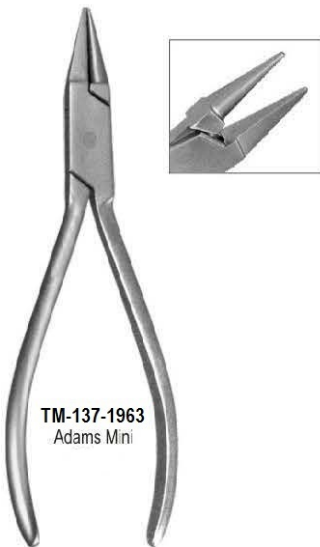
TM-137-1960
Adams Mini



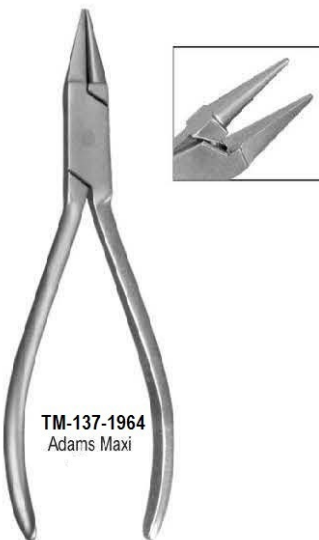
TM-137-1961
Adams Maxi



TM-137-1962
Round nose
Fine pattern



TM-137-1963
Adams Mini



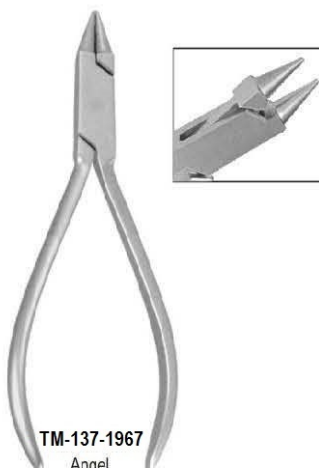
TM-137-1964
Adams Maxi



TM-137-1965
Light wire bending
& loop forming



TM-137-1966
Angel
Bird beak



TM-137-1967
Angel
Round nose wire
bending



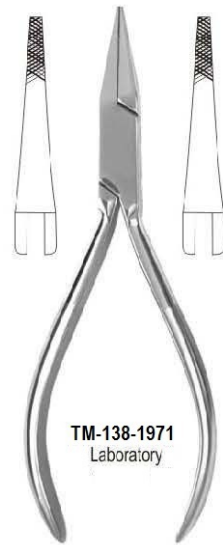
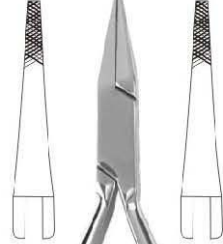
TM-137-1968
Angel
Round nose wire bending
& loop forming



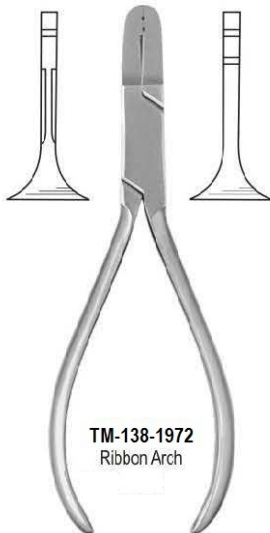
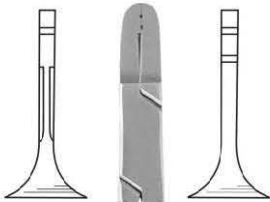
TM-138-1969
Serrated Laboratory



TM-138-1970
Smooth Laboratory



TM-138-1971
Laboratory



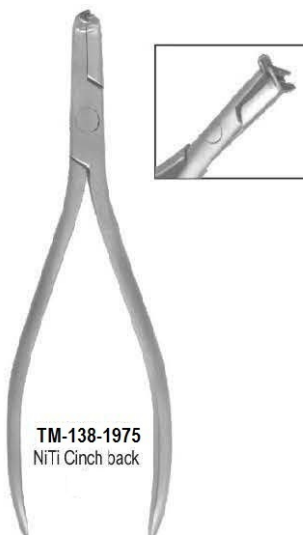
TM-138-1972
Ribbon Arch



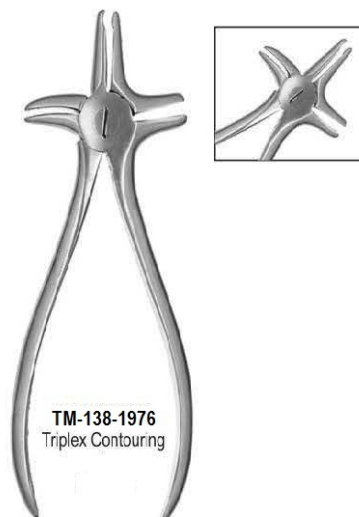
TM-138-1973
Cone & Socket



TM-138-1974
Goslee contouring



TM-138-1975
NiTi Cinch back



TM-138-1976
Triplex Contouring



TM-138-1977
Wire bending



TM-139-1978
De La Rosa
Graduated



TM-139-1979
De La Rosa
Smooth



TM-139-1980
Wire bending



TM-139-1981
Andresen wire
bending



TM-139-1982
Hawley retainer



TM-140-1983
Universal-Dolphin style
Wire bending & cutting



TM-140-1984
Nance
Adams clasp forming



TM-140-1985
Universal-Taper style
Wire bending & cutting



TM-140-1986
Schwarz
Arrow clasp forming



TM-140-1987
Waldasachs
Wire bending & cutting



TM-140-1988
Schwarz
Arrow clasp forming



TM-140-1989
Universal
parallel jaw
with side cutter



TM-140-1990
Magnum
Universal facebow loop
forming & cutting



TM-141-1991
Distal end cutter
with long handle TC



TM-141-1992
Distal end cutter
with long handle TC



TM-141-1993
Distal end cutter TC



TM-141-1994
soft wire & ligature TC



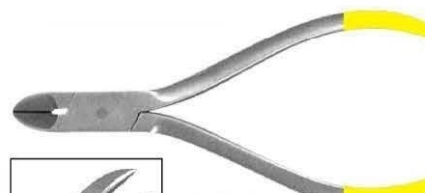
TM-141-1995
soft wire & ligature TC



TM-141-1996
soft wire & ligature
45° angled TC



TM-141-1997
Hard wire, straight TC



TM-141-1998
Hard wire cutter, 15° angled TC



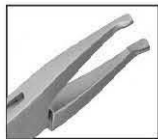
TM-142-1999
How Standard
4 mm wide tips TC



TM-142-2004
Soft wire & ligature



TM-142-2000
Angled
How Standard
4 mm wide tips TC



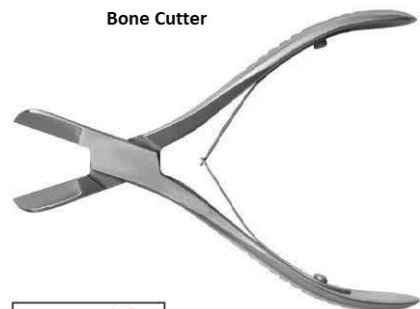
TM-142-2001
Straight
How Standard
4 mm wide tips TC



TM-142-2005
Goldman-Fox



TM-142-2002
Weingart Mini TC



Bone Cutter



TM-142-2003
Weingart TC



Liston Bone

- TM-142-2006 14 cm Straight
- TM-142-2008 17 cm Straight
- TM-142-2010 19 cm Straight
- TM-142-2012 22 cm Straight
- M-142-2007 14 cm Curved
- M-142-2009 17 cm Curved
- M-142-2011 19 cm Curved
- M-142-2013 22 cm Curved



TM-143-2014
Standard distal end cutter with safety hold



TM-143-2018
Soft wire & ligature, Mini



TM-143-2015
Mini head distal end cutter with safety hold



TM-143-2019
Soft wire and ligature, standard



TM-143-2016
Distal end cutter with safety hold, mini head, long handles



TM-143-2020
Soft wire & ligature; 15° angled



TM-143-2017
Flush-cut distal end cutter with safety hold



TM-143-2021
Soft wire & ligature, 45° angled



Utility



TM-144-2022
Weingart-Mini



TM-144-2023
Weingart

Utility



TM-144-2024
How
Straight



TM-144-2025
How
Angled



TM-144-2026
Angel (Bird beak)

Wire bending & loop forming



TM-144-2027

Light wire bending & loop forming



TM-144-2028

Light wire bending with cutter



TM-144-2029

Light wire bending & loop forming with cutter



TM-144-2030
Tweed

Light wire bending & loop forming , grooved tip



TM-145-2031
Hard wire, straight



TM-145-2032
Hard wire, 15° angled



TM-145-2033
Hard wire, 15° angled



TM-145-2034
Band removing



TM-145-2035
Bracket removing angled



TM-145-2036
Bracket removing straight



TM-145-2037
Bracket removing with plastic tip



TM-145-2038
Adhesive removing



TM-146-2040
Tweed
Loop forming with cutter



TM-146-2044
Hollow-Chop
Archwire forming , concave & convex tips



TM-146-2041
Jarabak
Light wire bending



TM-146-2045
Multi-purpose (bird beak, De la rosa & cutter in one)



TM-146-2042
Aderer
3-jaw wire bending



TM-146-2046
(Cinch back / tie back)
Distal end bending



TM-146-2043
Ligature forming



TM-146-2047
(Hammer head)
Distal end bending



TM-147-2048
Nance
Loop forming



TM-147-2052
Torquing set



TM-147-2049
Detailing step / Bayonet bending pliers - 1mm



TM-147-2053
Tweed / angel
Rectangular arch forming & torquing



TM-147-2050
Stop V-Bend - 1mm



TM-147-2054
Surgical ball hook crimping , angled



TM-147-2051
Lingual / palatal arch forming



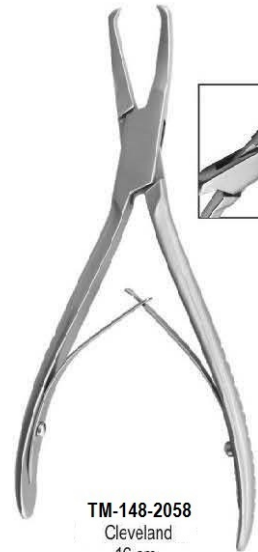
TM-147-2055
Surgical ball hook crimping , straight



TM-148-2056
Mead 1A
16.5 cm



TM-148-2057
Mead 2A
16.5 cm



TM-148-2058
Cleveland
16 cm



TM-148-2059
Luer Narrow
14 cm



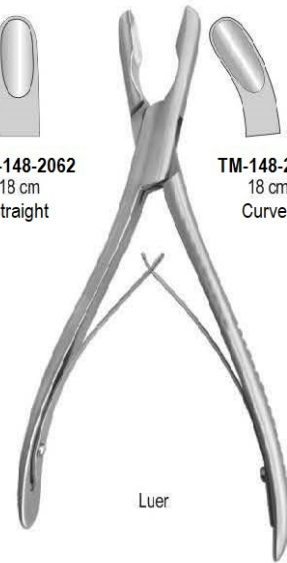
TM-148-2060
Luer wide
14 cm



TM-148-2062
18 cm
Straight



TM-148-2061
18 cm
Curved



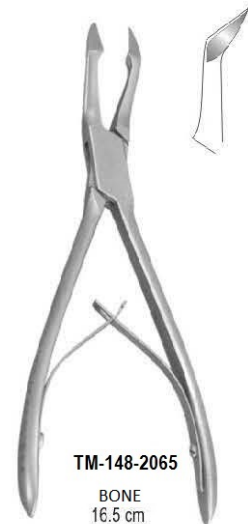
Luer



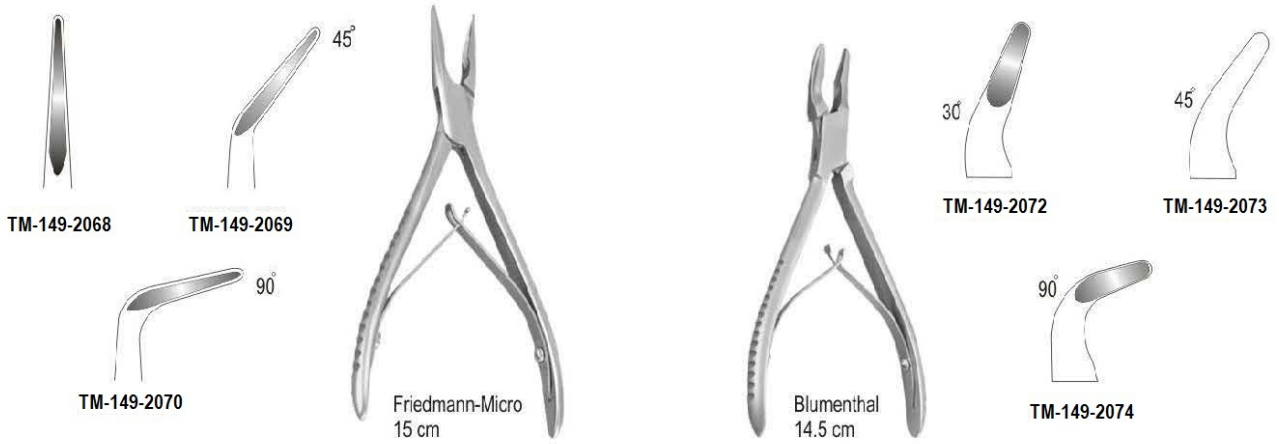
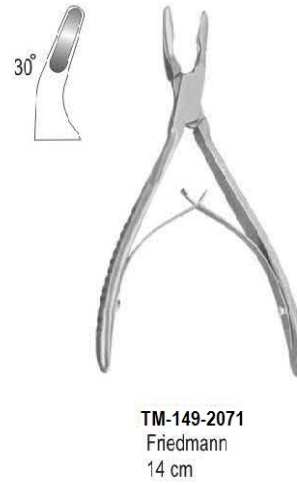
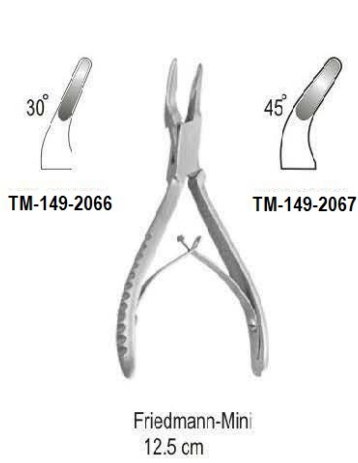
TM-148-2063
Cleveland 5
side cutting 17 cm



TM-148-2064
Cleveland 5A
side cutting 17 cm



TM-148-2065
BONE
16.5 cm





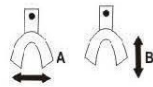
GROWELL TRADING SAS

Page

150-154

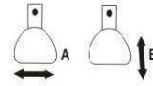
- DENTAL IMPRESSION TRAY
- DENTAL WAX CARVER

Perforated without Rim



| No. | Size | A mm | B mm | Code |
|-----|------|------|------|-------------|
| L1 | XXS | 55 | 47 | TM-150-2100 |
| L2 | XS | 60 | 49 | TM-150-2101 |
| L3 | S | 72 | 54 | TM-150-2102 |
| L4 | M | 74 | 57 | TM-150-2103 |
| L5 | L | 76 | 59 | TM-150-2104 |
| L6 | XL | 78 | 61 | TM-150-2105 |

Lower



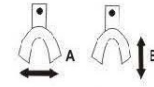
| No. | Size | A mm | B mm | Code |
|-----|------|------|------|-------------|
| U1 | XXS | 61 | 47 | TM-150-2106 |
| U2 | XS | 64 | 51 | TM-150-2107 |
| U3 | S | 66 | 53 | TM-150-2108 |
| U4 | M | 69 | 57 | TM-150-2109 |
| U5 | L | 71 | 60 | TM-150-2110 |
| U6 | XL | 73 | 62 | TM-150-2111 |

Upper

| Set | Contents | Code |
|--------|--|-------------|
| 6 Pcs | L3,L4,L5,U3,U4,U5 | TM-150-2112 |
| 8 Pcs | L3,L4,L5,L6,U3,U4,U5,U6 | TM-150-2113 |
| 12 Pcs | L1,L2,L3,L4,L5,L6 U1,U2,U3,U4,U5,U6 | TM-150-2114 |

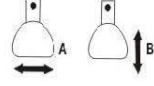


Perforated with Rim



| No. | Size | A mm | B mm | Code |
|-----|------|------|------|-------------|
| L1 | XXS | 55 | 47 | TM-150-2115 |
| L2 | XS | 60 | 49 | TM-150-2116 |
| L3 | S | 72 | 54 | TM-150-2117 |
| L4 | M | 74 | 57 | TM-150-2118 |
| L5 | L | 76 | 59 | TM-150-2119 |
| L6 | XL | 78 | 61 | TM-150-2120 |

Lower



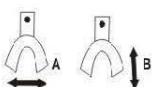
| No. | Size | A mm | B mm | Code |
|-----|------|------|------|-------------|
| U1 | XXS | 61 | 47 | TM-150-2121 |
| U2 | XS | 64 | 51 | TM-150-2122 |
| U3 | S | 66 | 53 | TM-150-2123 |
| U4 | M | 69 | 57 | TM-150-2124 |
| U5 | L | 71 | 60 | TM-150-2125 |
| U6 | XL | 73 | 62 | TM-150-2126 |

Upper

| Set | Contents | Code |
|--------|--|-------------|
| 6 Pcs | L3,L4,L5,U3,U4,U5 | TM-150-2127 |
| 8 Pcs | L3,L4,L5,L6,U3,U4,U5,U6 | TM-150-2128 |
| 12 Pcs | L1,L2,L3,L4,L5,L6 U1,U2,U3,U4,U5,U6 | TM-150-2129 |

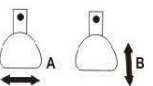


Solid without Rim



| No. | Size | A mm | B mm | Code |
|-----|------|------|------|-------------|
| L1 | XXS | 55 | 47 | TM-150-2130 |
| L2 | XS | 60 | 49 | TM-150-2131 |
| L3 | S | 72 | 54 | TM-150-2132 |
| L4 | M | 74 | 57 | TM-150-2133 |
| L5 | L | 76 | 59 | TM-150-2134 |
| L6 | XL | 78 | 61 | TM-150-2135 |

Lower



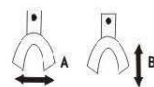
| No. | Size | A mm | B mm | Code |
|-----|------|------|------|-------------|
| U1 | XXS | 61 | 47 | TM-150-2136 |
| U2 | XS | 64 | 51 | TM-150-2137 |
| U3 | S | 66 | 53 | TM-150-2138 |
| U4 | M | 69 | 57 | TM-150-2139 |
| U5 | L | 71 | 60 | TM-150-2140 |
| U6 | XL | 73 | 62 | TM-150-2141 |

Upper

| Set | Contents | Code |
|--------|--|-------------|
| 6 Pcs | L3,L4,L5,U3,U4,U5 | TM-150-2142 |
| 8 Pcs | L3,L4,L5,L6,U3,U4,U5,U6 | TM-150-2143 |
| 12 Pcs | L1,L2,L3,L4,L5,L6 U1,U2,U3,U4,U5,U6 | TM-150-2144 |

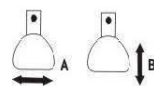


Solid with Rim



| No. | Size | A mm | B mm | Code |
|-----|------|------|------|-------------|
| L1 | XXS | 55 | 47 | TM-150-2145 |
| L2 | XS | 60 | 49 | TM-150-2146 |
| L3 | S | 72 | 54 | TM-150-2147 |
| L4 | M | 74 | 57 | TM-150-2148 |
| L5 | L | 76 | 59 | TM-150-2149 |
| L6 | XL | 78 | 61 | TM-150-2150 |

Lower



| No. | Size | A mm | B mm | Code |
|-----|------|------|------|-------------|
| U1 | XXS | 61 | 47 | TM-150-2151 |
| U2 | XS | 64 | 51 | TM-150-2152 |
| U3 | S | 66 | 53 | TM-150-2153 |
| U4 | M | 69 | 57 | TM-150-2154 |
| U5 | L | 71 | 60 | TM-150-2155 |
| U6 | XL | 73 | 62 | TM-150-2156 |

Upper

| Set | Contents | Code |
|--------|--|-------------|
| 6 Pcs | L3,L4,L5,U3,U4,U5 | TM-150-2157 |
| 8 Pcs | L3,L4,L5,L6,U3,U4,U5,U6 | TM-150-2158 |
| 12 Pcs | L1,L2,L3,L4,L5,L6 U1,U2,U3,U4,U5,U6 | TM-150-2159 |

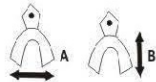




Regular Perforated with Rim



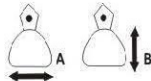
Lower



| No. | Size | A mm | B mm | Code |
|-----|------|------|------|-------------|
| L1 | XL | 80 | 63 | TM-151-2160 |
| L2 | L | 78 | 59 | TM-151-2161 |
| L3 | M | 76 | 57 | TM-151-2162 |
| L4 | S | 72 | 57 | TM-151-2163 |
| L5 | XS | 69 | 50 | TM-151-2164 |



Upper



| No. | Size | A mm | B mm | Code |
|-----|------|------|------|-------------|
| U1 | XL | 80 | 63 | TM-151-2165 |
| U2 | L | 78 | 59 | TM-151-2166 |
| U3 | M | 76 | 57 | TM-151-2167 |
| U4 | S | 72 | 57 | TM-151-2168 |
| U5 | XS | 69 | 50 | TM-151-2169 |

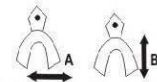
| Set | Contents | Code |
|--------|--------------------------------|-------------|
| 10 Pcs | L1,L2,L3,L4,L5, U1,U2,U3,U4,U5 | TM-151-2170 |



Regular Solid with Rim



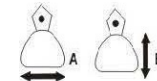
Lower



| No. | Size | A mm | B mm | Code |
|-----|------|------|------|-------------|
| L1 | XL | 80 | 63 | TM-151-2171 |
| L2 | L | 78 | 59 | TM-151-2172 |
| L3 | M | 76 | 57 | TM-151-2173 |
| L4 | S | 72 | 57 | TM-151-2174 |
| L5 | XS | 69 | 50 | TM-151-2175 |



Upper



| No. | Size | A mm | B mm | Code |
|-----|------|------|------|-------------|
| U1 | XL | 80 | 63 | TM-151-2176 |
| U2 | L | 78 | 59 | TM-151-2177 |
| U3 | M | 76 | 57 | TM-151-2178 |
| U4 | S | 72 | 57 | TM-151-2179 |
| U5 | XS | 69 | 50 | TM-151-2180 |

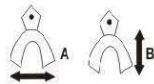
| Set | Contents | Code |
|--------|--------------------------------|-------------|
| 10 Pcs | L1,L2,L3,L4,L5, U1,U2,U3,U4,U5 | TM-151-2181 |



Children Perforated with Rim



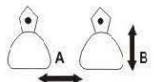
Lower



| No. | Size | A mm | B mm | Code |
|-----|------|------|------|-------------|
| L1 | S | 54 | 47 | TM-151-2182 |
| L2 | M | 62 | 51 | TM-151-2183 |
| L3 | L | 70 | 55 | TM-151-2184 |



Upper



| No. | Size | A mm | B mm | Code |
|-----|------|------|------|-------------|
| U1 | S | 55 | 43 | TM-151-2185 |
| U2 | M | 60 | 45 | TM-151-2186 |
| U3 | L | 63 | 49 | TM-151-2187 |

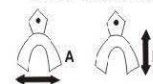
| Set | Contents | Code |
|-------|-------------------|-------------|
| 6 Pcs | L1,L2,L3,U1,U2,U3 | TM-151-2188 |



Children Solid with Rim



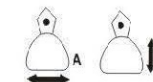
Lower



| No. | Size | A mm | B mm | Code |
|-----|------|------|------|-------------|
| L1 | S | 54 | 47 | TM-151-2189 |
| L2 | M | 62 | 51 | TM-151-2190 |
| L3 | L | 70 | 55 | TM-151-2191 |



Upper



| No. | Size | A mm | B mm | Code |
|-----|------|------|------|-------------|
| U1 | S | 55 | 43 | TM-151-2192 |
| U2 | M | 60 | 45 | TM-151-2193 |
| U3 | L | 63 | 49 | TM-151-2194 |

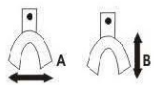
| Set | Contents | Code |
|-------|-------------------|-------------|
| 6 Pcs | L1,L2,L3,U1,U2,U3 | TM-151-2195 |



Ehrlicke Pattern Perforated



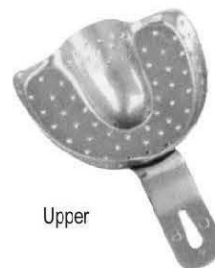
Lower



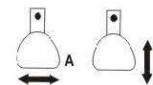
| No. | Size | A mm | B mm | Code |
|-----|------|------|------|-------------|
| UB0 | XS | 65 | 46 | TM-151-2196 |
| UB1 | S | 67 | 50 | TM-151-2197 |
| UB2 | M | 76 | 54 | TM-151-2198 |
| UB3 | L | 79 | 56 | TM-151-2199 |
| UB4 | XL | 79 | 61 | TM-151-2200 |



| Set | Contents | Code |
|--------|--|-------------|
| 10 Pcs | LB0, LB1, LB2, LB3, LB4, UB0, UB1, UB2, UB3, UB4 | TM-151-2206 |



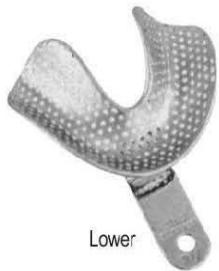
Upper



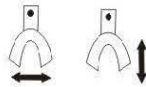
| No. | Size | A mm | B mm | Code |
|-----|------|------|------|-------------|
| UB0 | XS | 59 | 52 | TM-151-2201 |
| UB1 | S | 66 | 52 | TM-151-2202 |
| UB2 | M | 71 | 62 | TM-151-2203 |
| UB3 | L | 71 | 64 | TM-151-2204 |
| UB4 | XL | 80 | 70 | TM-151-2205 |

Dental Impression Tray

Edentulous Perforated with Rim



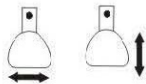
Lower



| No. | Size | A mm | B mm | Code |
|-----|------|------|------|-------------|
| L1 | XL | 84 | 65 | TM-152-2207 |
| L2 | L | 77 | 64 | TM-152-2208 |
| L3 | M | 76 | 60 | TM-152-2209 |
| L4 | S | 68 | 57 | TM-152-2210 |



Upper



| No. | Size | A mm | B mm | Code |
|-----|------|------|------|-------------|
| U1 | XL | 80 | 62 | TM-152-2211 |
| U2 | L | 77 | 60 | TM-152-2212 |
| U3 | M | 70 | 60 | TM-152-2213 |
| U4 | S | 72 | 56 | TM-152-2214 |

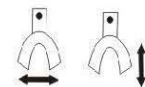
| Set | Contents | Code |
|-------|-------------------------|-------------|
| 8 Pcs | L1,L2,L3,L4,U1,U2,U3,U4 | TM-152-2215 |



Edentulous Solid with Rim



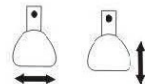
Lower



| No. | Size | A mm | B mm | Code |
|-----|------|------|------|-------------|
| L1 | XL | 84 | 65 | TM-152-2216 |
| L2 | L | 77 | 64 | TM-152-2217 |
| L3 | M | 76 | 60 | TM-152-2218 |
| L4 | S | 68 | 57 | TM-152-2219 |



Upper



| No. | Size | A mm | B mm | Code |
|-----|------|------|------|-------------|
| U1 | XL | 80 | 62 | TM-152-2220 |
| U2 | L | 77 | 60 | TM-152-2221 |
| U3 | M | 70 | 60 | TM-152-2222 |
| U4 | S | 72 | 56 | TM-152-2223 |

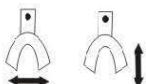
| Set | Contents | Code |
|-------|-------------------------|-------------|
| 8 Pcs | L1,L2,L3,L4,U1,U2,U3,U4 | TM-152-2224 |



Anterior Depressed Perforated with Rim



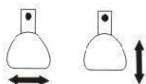
Lower



| No. | Size | A mm | B mm | Code |
|-----|------|------|------|-------------|
| L1 | S | 65 | 48 | TM-152-2225 |
| L2 | M | 72 | 57 | TM-152-2226 |
| L3 | L | 75 | 57 | TM-152-2227 |



Upper



| No. | Size | A mm | B mm | Code |
|-----|------|------|------|-------------|
| U1 | S | 64 | 56 | TM-152-2228 |
| U2 | M | 67 | 60 | TM-152-2229 |
| U3 | L | 72 | 63 | TM-152-2230 |

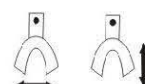
| Set | Contents | Code |
|-------|-------------------|-------------|
| 6 Pcs | L1,L2,L3,U1,U2,U3 | TM-152-2231 |



Anterior Depressed Solid with Rim



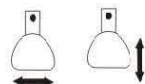
Lower



| No. | Size | A mm | B mm | Code |
|-----|------|------|------|-------------|
| L1 | S | 65 | 48 | TM-152-2232 |
| L2 | M | 72 | 57 | TM-152-2233 |
| L3 | L | 75 | 57 | TM-152-2234 |



Upper



| No. | Size | A mm | B mm | Code |
|-----|------|------|------|-------------|
| U1 | S | 64 | 56 | TM-152-2235 |
| U2 | M | 67 | 60 | TM-152-2236 |
| U3 | L | 72 | 63 | TM-152-2237 |

| Set | Contents | Code |
|-------|-------------------|-------------|
| 6 Pcs | L1,L2,L3,U1,U2,U3 | TM-152-2238 |





Partial Perforated with Rim



Fig. 30
TM-153-2239
Upper Left / Lower Right



Fig. 31
TM-153-2240
Lower Left / Upper Right



Fig. 32
TM-153-2241
Lower Jaw



Fig. 33
TM-153-2242
Upper Jaw



Fig. 99
TM-153-2243
Lateral

Partial Solid with Rim



Fig. 30
TM-153-2244
Upper Left / Lower Right



Fig. 31
TM-153-2245
Lower Left / Upper Right



Fig. 32
TM-153-2246
Lower Jaw



Fig. 33
TM-153-2247
Upper Jaw



Fig. 99
TM-153-2248
Lateral

Perforated without Rim



| Lower Left / Upper Right | | |
|--------------------------|------|-------------|
| No. | Size | Code |
| Fig. L2D | S | TM-153-2249 |
| Fig. L4D | M | TM-153-2250 |
| Fig. L6D | L | TM-153-2251 |



| Upper Left / Lower Right | | |
|--------------------------|------|-------------|
| No. | Size | Code |
| Fig. L2S | S | TM-153-2255 |
| Fig. L4S | M | TM-153-2256 |
| Fig. L6S | L | TM-153-2257 |

Perforated with Rim



| Lower Left / Upper Right | | |
|--------------------------|------|-------------|
| No. | Size | Code |
| Fig. L2D | S | TM-153-2252 |
| Fig. L4D | M | TM-153-2253 |
| Fig. L6D | L | TM-153-2254 |



| Upper Left / Lower Right | | |
|--------------------------|------|-------------|
| No. | Size | Code |
| Fig. L2S | S | TM-153-2258 |
| Fig. L4S | M | TM-153-2259 |
| Fig. L6S | L | TM-153-2260 |

Carvers For Silicon impression Material Solid Handle



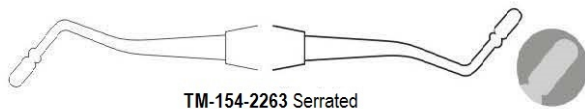
TM-154-2261

Carvers For Silicon impression Material Hollow Handle

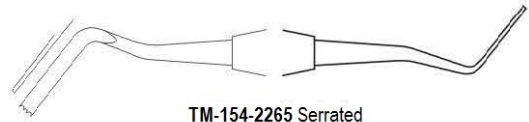


TM-154-2262

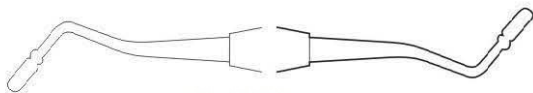
Gingival cord packers



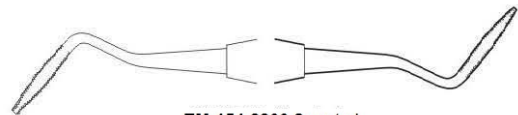
TM-154-2263 Serrated



TM-154-2265 Serrated



TM-154-2264 Smooth



TM-154-2266 Serrated



GROWELL TRADING SAS

Page

155-164

- STERILIZATION CONTAINER
- INSTRUMENT TRAY
- TISSUE FORCEPS SCISSORS
- DENTAL DRESSING FORCEPS



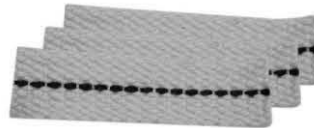
TM-155-2300 Spirit Lamp 120 cc



TM-155-2301 Spirit Lamp 120 cc



TM-155-2302 Spirit Lamp 120 cc



TM-155-2303 Spare wicks Flat 12mm (pack of 5)



TM-155-2304 Spare wicks Round \varnothing 4mm (pack of 5)



Forceps Jars

| TM-155-2305 | 30 x 90 mm |
|-------------|--------------|
| TM-155-2306 | 50 x 100 mm |
| TM-155-2307 | 50 x 130 mm |
| TM-155-2308 | 50 x 175 mm |
| TM-155-2309 | 75 x 100 mm |
| TM-155-2310 | 75 x 130 mm |
| TM-155-2311 | 75 x 175 mm |
| TM-155-2312 | 100 x 175 mm |
| TM-155-2313 | 100 x 200 mm |



Dressing Jars With Lid & Knob

| | |
|-------------|-----------------|
| TM-155-2314 | 75 mm x 60 mm |
| TM-155-2315 | 75 mm x 75 mm |
| TM-155-2316 | 100 mm x 60 mm |
| TM-155-2317 | 100 mm x 100 mm |
| TM-155-2318 | 125 mm x 80 mm |
| TM-155-2319 | 125 mm x 125 mm |
| TM-155-2320 | 150 mm x 150 mm |



Dressing Jars / Cotton Containers

| | |
|-------------|--------------|
| TM-155-2321 | 80 x 60 mm |
| TM-155-2322 | 80 x 80 mm |
| TM-155-2323 | 100 x 60 mm |
| TM-155-2324 | 100 x 80 mm |
| TM-155-2325 | 100 x 100 mm |
| TM-155-2326 | 120 x 80 mm |
| TM-155-2327 | 120 x 100 mm |
| TM-155-2328 | 120 x 120 mm |
| TM-155-2329 | 150 x 100 mm |
| TM-155-2330 | 150 x 150 mm |
| TM-155-2331 | 180 x 150 mm |
| TM-155-2332 | 180 x 180 mm |
| TM-155-2333 | 200 x 200 mm |
| TM-155-2334 | 240 x 240 mm |



| Gallipot | |
|-------------|--------|
| | vcl. |
| TM-156-2335 | 50 ml |
| TM-156-2336 | 100 ml |
| TM-156-2337 | 150 ml |
| TM-156-2338 | 225 ml |



| Stainless Steel Round Bowls | | | |
|-----------------------------|----------|--------|-------|
| | dia. | height | vol. |
| TM-156-2339 | Ø 40 mm | 19 mm | 0.05L |
| TM-156-2340 | Ø 60 mm | 30 mm | 0.07L |
| TM-156-2341 | Ø 80 mm | 40 mm | 0.14L |
| TM-156-2342 | Ø 100 mm | 50 mm | 0.35L |
| TM-156-2343 | Ø 120 mm | 60 mm | 0.45L |
| TM-156-2344 | Ø 150 mm | 70 mm | 0.70L |
| TM-156-2345 | Ø 180 mm | 90 mm | 1.10L |
| TM-156-2346 | Ø 200 mm | 100 mm | 1.60L |



| Stainless Steel Bowls | | | |
|-----------------------|----------|--------|-------|
| | dia. | height | vol. |
| TM-156-2347 | Ø 40 mm | 19 mm | 0.05L |
| TM-156-2348 | Ø 60 mm | 30 mm | 0.07L |
| TM-156-2349 | Ø 80 mm | 40 mm | 0.14L |
| TM-156-2350 | Ø 100 mm | 50 mm | 0.35L |
| TM-156-2351 | Ø 120 mm | 60 mm | 0.45L |
| TM-156-2352 | Ø 150 mm | 70 mm | 0.70L |
| TM-156-2353 | Ø 180 mm | 90 mm | 1.10L |
| TM-156-2354 | Ø 200 mm | 100 mm | 1.60L |



| Wash Basins | |
|-------------|--------|
| | dia. |
| TM-156-2355 | 300 mm |
| TM-156-2356 | 320 mm |
| TM-156-2357 | 350 mm |
| TM-156-2358 | 400 mm |



| Medicine Cup | |
|--------------|-------------|
| | dia. height |
| TM-156-2359 | 80 x 35 mm |
| TM-156-2360 | 125 x 60 mm |



| Medicine Cup (Graduated) | |
|--------------------------|----------------------|
| | Size (mm) Cap.(ml) |
| TM-156-2361 | 2 Oz. 60 ml |



| Kidney Trays With LID | |
|-----------------------|--------|
| | dia. |
| TM-156-2362 | 150 mm |
| TM-156-2363 | 200 mm |
| TM-156-2364 | 250 mm |
| TM-156-2365 | 300 mm |



| Kidney Trays | |
|--------------|--------|
| | dia. |
| TM-156-2366 | 150 mm |
| TM-156-2367 | 200 mm |
| TM-156-2368 | 250 mm |
| TM-156-2369 | 300 mm |



| Kidney Trays Shallow | |
|----------------------|--------|
| | dia. |
| TM-156-2370 | 150 mm |
| TM-156-2371 | 200 mm |
| TM-156-2372 | 250 mm |
| TM-156-2373 | 300 mm |



Instrument Tray



| Scalers Trays | |
|--------------------|-------------------|
| TM-157-2374 | 190 x 100 x 17 mm |
| TM-157-2375 | 200 x 100 x 25 mm |



| Scalers Trays | |
|--------------------|------------------|
| TM-157-2376 | 185 x 80 x 15 mm |



| Instruments Trays With LID | |
|----------------------------|-------------------|
| TM-157-2377 | 150 x 100 x 50 mm |
| TM-157-2378 | 200 x 100 x 50 mm |
| TM-157-2379 | 220 x 120 x 50 mm |
| TM-157-2380 | 240 x 140 x 50 mm |
| TM-157-2381 | 200 x 150 x 50 mm |
| TM-157-2382 | 250 x 200 x 50 mm |
| TM-157-2383 | 300 x 250 x 50 mm |
| TM-157-2384 | 300 x 200 x 50 mm |
| TM-157-2385 | 350 x 250 x 50 mm |
| TM-157-2386 | 400 x 300 x 50 mm |
| TM-157-2387 | 450 x 300 x 50 mm |
| TM-157-2388 | 450 x 350 x 50 mm |



| Instruments Trays Without LID | |
|-------------------------------|-------------------|
| TM-157-2389 | 150 x 100 x 50 mm |
| TM-157-2390 | 200 x 100 x 50 mm |
| TM-157-2391 | 220 x 120 x 50 mm |
| TM-157-2392 | 240 x 140 x 50 mm |
| TM-157-2393 | 200 x 150 x 50 mm |
| TM-157-2394 | 250 x 200 x 50 mm |
| TM-157-2395 | 300 x 250 x 50 mm |
| TM-157-2396 | 300 x 200 x 50 mm |
| TM-157-2397 | 350 x 250 x 50 mm |
| TM-157-2398 | 400 x 300 x 50 mm |
| TM-157-2399 | 450 x 300 x 50 mm |
| TM-157-2400 | 450 x 350 x 50 mm |



| Instruments Trays | |
|-------------------|-------------------|
| TM-158-2401 | 210 x 160 x 10 mm |
| TM-158-2402 | 240 x 180 x 10 mm |
| TM-158-2403 | 310 x 150 x 10 mm |
| TM-158-2404 | 310 x 210 x 10 mm |
| TM-158-2405 | 350 x 240 x 10 mm |
| TM-158-2406 | 400 x 270 x 10 mm |
| TM-158-2407 | 420 x 280 x 10 mm |



| Mayo Trays Perforated | |
|-----------------------|-------------------|
| TM-158-2408 | 150 x 100 x 50 mm |
| TM-158-2409 | 200 x 100 x 50 mm |
| TM-158-2410 | 220 x 120 x 50 mm |
| TM-158-2411 | 240 x 140 x 50 mm |
| TM-158-2412 | 200 x 150 x 50 mm |
| TM-158-2413 | 250 x 200 x 50 mm |
| TM-158-2414 | 300 x 200 x 50 mm |
| TM-158-2415 | 300 x 250 x 50 mm |
| TM-158-2416 | 350 x 250 x 50 mm |
| TM-158-2417 | 400 x 300 x 50 mm |
| TM-158-2418 | 450 x 300 x 50 mm |
| TM-158-2419 | 450 x 350 x 50 mm |



| DIN Baskets perforated sides | |
|------------------------------|--------------------|
| TM-158-2420 | 240 x 240 x 50 mm |
| TM-158-2421 | 240 x 240 x 100 mm |
| TM-158-2422 | 480 x 260 x 50 mm |
| TM-158-2423 | 520 x 260 x 80 mm |
| TM-158-2424 | 520 x 260 x 100 mm |



| Wiremesh Baskets perforated | |
|-----------------------------|--------------------|
| TM-158-2425 | 240 x 240 x 50 mm |
| TM-158-2426 | 260 x 240 x 100 mm |
| TM-158-2427 | 480 x 260 x 50 mm |
| TM-158-2428 | 520 x 260 x 80 mm |
| TM-158-2429 | 520 x 260 x 100 mm |



Sterilization Container



| Instrument Boxes With Side Handle | |
|-----------------------------------|-------------------|
| TM-159-2430 | 150 x 100 x 50 mm |
| TM-159-2431 | 200 x 100 x 50 mm |
| TM-159-2432 | 220 x 120 x 50 mm |
| TM-159-2433 | 240 x 140 x 50 mm |
| TM-159-2434 | 200 x 150 x 50 mm |
| TM-159-2435 | 250 x 200 x 50 mm |
| TM-159-2436 | 300 x 200 x 50 mm |
| TM-159-2437 | 300 x 250 x 50 mm |
| TM-159-2438 | 400 x 300 x 50 mm |
| TM-159-2439 | 450 x 300 x 50 mm |
| TM-159-2440 | 450 x 350 x 50 mm |

| Instrument Boxes With LID | |
|---------------------------|-------------------|
| TM-159-2441 | 150 x 100 x 50 mm |
| TM-159-2442 | 200 x 100 x 50 mm |
| TM-159-2443 | 220 x 120 x 50 mm |
| TM-159-2444 | 240 x 140 x 50 mm |
| TM-159-2445 | 200 x 150 x 50 mm |
| TM-159-2446 | 250 x 200 x 50 mm |
| TM-159-2447 | 300 x 200 x 50 mm |
| TM-159-2448 | 300 x 250 x 50 mm |
| TM-159-2449 | 400 x 300 x 50 mm |
| TM-159-2450 | 400 x 300 x 50 mm |
| TM-159-2451 | 450 x 350 x 50 mm |



| Perforated Instruments Boxes | |
|------------------------------|--------------------|
| TM-159-2452 | 170 x 070 x 35 mm |
| TM-159-2453 | 180 x 080 x 40 mm |
| TM-159-2454 | 200 x 100 x 40 mm |
| TM-159-2455 | 200 x 100 x 50 mm |
| TM-159-2456 | 200 x 100 x 60 mm |
| TM-159-2457 | 220 x 120 x 60 mm |
| TM-159-2458 | 250 x 120 x 60 mm |
| TM-159-2459 | 300 x 150 x 60 mm |
| TM-159-2460 | 300 x 200 x 80 mm |
| TM-159-2461 | 400 x 160 x 80 mm |
| TM-159-2462 | 400 x 200 x 100 mm |
| TM-159-2463 | 500 x 200 x 120 mm |

| Perforated Instruments Boxes | |
|------------------------------|--------------------|
| TM-159-2464 | 170 x 070 x 35 mm |
| TM-159-2465 | 180 x 080 x 40 mm |
| TM-159-2466 | 200 x 100 x 40 mm |
| TM-159-2467 | 200 x 100 x 50 mm |
| TM-159-2468 | 200 x 100 x 60 mm |
| TM-159-2469 | 220 x 120 x 60 mm |
| TM-159-2470 | 250 x 120 x 60 mm |
| TM-159-2471 | 300 x 150 x 60 mm |
| TM-159-2472 | 300 x 200 x 80 mm |
| TM-159-2473 | 400 x 160 x 80 mm |
| TM-159-2474 | 400 x 200 x 100 mm |
| TM-159-2475 | 500 x 200 x 120 mm |



| Catheter trays with cover | |
|---------------------------|-------------------|
| TM-160-2476 | 100 x 200 x 50 mm |
| TM-160-2477 | 100 x 300 x 50 mm |
| TM-160-2478 | 120 x 220 x 50 mm |



| Instruments Boxes Perforated | |
|------------------------------|-------------------|
| TM-160-2479 | 180 x 80 x 30 mm |
| TM-160-2480 | 180 x 80 x 40 mm |
| TM-160-2481 | 180 x 80 x 50 mm |
| TM-160-2482 | 200 x 90 x 30 mm |
| TM-160-2483 | 200 x 90 x 40 mm |
| TM-160-2484 | 200 x 90 x 50 mm |
| TM-160-2485 | 250 x 100 x 40 mm |
| TM-160-2486 | 250 x 100 x 50 mm |
| TM-160-2487 | 250 x 100 x 60 mm |

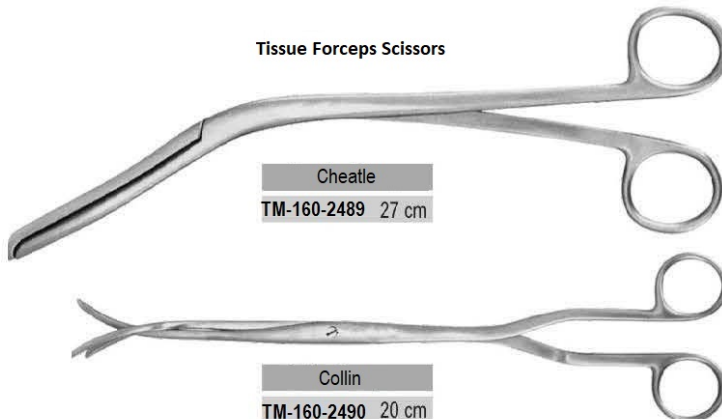


| Thermometer Jar | |
|-----------------|---------------|
| TM-160-2488 | Ø 25 x 100 mm |



| Instruments Boxes With Filters | |
|--------------------------------|--------------------|
| TM-160-2492 | 170 x 070 x 35 mm |
| TM-160-2493 | 180 x 080 x 40 mm |
| TM-160-2494 | 200 x 100 x 40 mm |
| TM-160-2495 | 200 x 100 x 50 mm |
| TM-160-2496 | 200 x 100 x 60 mm |
| TM-160-2497 | 220 x 120 x 60 mm |
| TM-160-2498 | 250 x 120 x 60 mm |
| TM-160-2499 | 300 x 150 x 60 mm |
| TM-160-2500 | 300 x 200 x 80 mm |
| TM-160-2501 | 400 x 160 x 80 mm |
| TM-160-2502 | 400 x 200 x 100 mm |
| TM-160-2503 | 500 x 200 x 120 mm |

Tissue Forceps Scissors



| Cheate | |
|-------------|-------|
| TM-160-2489 | 27 cm |

| Collin | |
|-------------|-------|
| TM-160-2490 | 20 cm |
| TM-160-2491 | 30 cm |



| Irrigators | |
|-------------|------|
| | vol. |
| TM-161-2504 | 1.0L |
| TM-161-2505 | 1.5L |
| TM-161-2506 | 2.0L |



| Measuring Jugs | |
|----------------|---------|
| | vol. |
| TM-161-2507 | 250 ml |
| TM-161-2508 | 500 ml |
| TM-161-2509 | 1000 ml |
| TM-161-2510 | 2000 ml |



| Measuring Jugs | |
|----------------|---------|
| | vcl. |
| TM-161-2511 | 250 ml |
| TM-161-2512 | 500 ml |
| TM-161-2513 | 1000 ml |
| TM-161-2514 | 2000 ml |



| Buckets With LID | | Buckets Without LID | |
|------------------|-------|---------------------|-------|
| | vol. | | vol. |
| TM-161-2515 | 8.0L | TM-161-2518 | 8.0L |
| TM-161-2516 | 10.0L | TM-161-2519 | 10.0L |
| TM-161-2517 | 15.0L | TM-161-2520 | 0L |



| Sputum Cup | |
|-------------|---------------|
| | dia. height |
| TM-161-2521 | Ø 75 x 80 mm |
| TM-161-2522 | Ø 100 x 50 mm |
| TM-161-2523 | Ø 100 x 80 mm |



| Ointment Jar | | |
|--------------|--------------|-------|
| | dia. height | Vol. |
| TM-161-2524 | Ø 75 x 65 mm | 250ml |



| Needle Case | |
|-------------|-------------------|
| TM-162-2525 | 210 x 125 x 17 mm |



| Needle Case Sauerbruch | |
|------------------------|-------------------|
| TM-162-2526 | 210 x 125 x 17 mm |



| Needle Case | |
|-------------|------------------|
| TM-162-2527 | 150 x 90 x 10 mm |



| Needle Cases Perforated | |
|-------------------------|------------------|
| TM-162-2528 | 50 x 25 x 4.5 mm |
| TM-162-2529 | 65 x 42 x 8 mm |
| TM-162-2530 | 75 x 25 x 4.5 mm |



| Needle Cases Plain | |
|--------------------|------------------|
| TM-162-2531 | 50 x 25 x 4.5 mm |
| TM-162-2532 | 65 x 42 x 8 mm |
| TM-162-2533 | 75 x 25 x 4.5 mm |



| Needle Case Complete | |
|----------------------|--|
| TM-162-2534 | |



| Funnels | |
|-------------|--------|
| | dia. |
| TM-162-2535 | 100 mm |
| TM-162-2536 | 120 mm |
| TM-162-2537 | 150 mm |
| TM-162-2538 | 200 mm |
| TM-162-2539 | 240 mm |



| Petri Dishes | |
|--------------|-------------|
| | dia. height |
| TM-162-2540 | 60 x 20 mm |
| TM-162-2541 | 90 x 15 mm |
| TM-162-2542 | 100 x 20 mm |
| TM-162-2543 | 120 x 20 mm |



Instrument Tray , Dental Dressing Forceps



Chico
Stainless Steel for 5 instruments
TM-163-2544 180 x 60 x 22 mm



Medio
Stainless Steel for 10 instruments
TM-163-2545 180 x 125 x 22 mm



Maxi
Stainless Steel for 20 instruments
TM-163-2546 280 x 180 x 25 mm



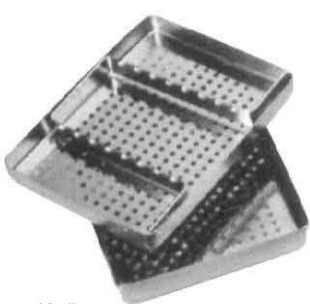
Maxi Set 1
Stainless Steel rack for 15 instruments
TM-163-2547 288 x 187 x 40 mm



Maxi Set 2
Stainless Steel for 15 instruments
TM-163-2548 288 x 187 x 40 mm



Maxi Set 3
Stainless Steel for 15 instruments
TM-163-2549 288 x 187 x 40 mm



Medio
Stainless Steel Perforated Tray with cover
TM-163-2550 187 x 145 x 25 mm



Medio
Stainless Steel Solid Tray with cover
TM-163-2551 187 x 145 x 25 mm



Burs Disinfecting Box Stainless Steel
TM-163-2552 90 mm x 40 mm



Mesh Burs Holder
TM-163-2553 35 mm x 150 mm



Dental Dressing Forceps
TM-163-2554 Bur Holding Tweezer 16.5 cm



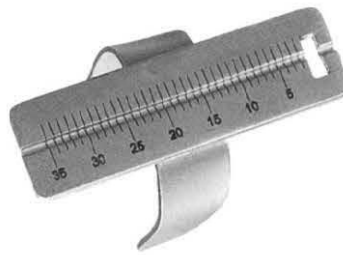
| Perforated Instruments Boxes | |
|------------------------------|--------------------|
| TM-164-2555 | 170 x 070 x 35 mm |
| TM-164-2556 | 180 x 080 x 40 mm |
| TM-164-2557 | 200 x 100 x 40 mm |
| TM-164-2558 | 200 x 100 x 50 mm |
| TM-164-2559 | 200 x 100 x 60 mm |
| TM-164-2560 | 220 x 120 x 60 mm |
| TM-164-2561 | 250 x 120 x 60 mm |
| TM-164-2562 | 300 x 150 x 60 mm |
| TM-164-2563 | 300 x 200 x 80 mm |
| TM-164-2564 | 400 x 160 x 80 mm |
| TM-164-2565 | 400 x 200 x 100 mm |
| TM-164-2566 | 500 x 200 x 120 mm |



Stainless Steel endodontic tray with cover
TM-164-2567 250 x 115 x 15 mm



Instrument Box perforated
TM-164-2568 180 x 90 x 30 mm



TM-164-2569 Endometer Laser etched



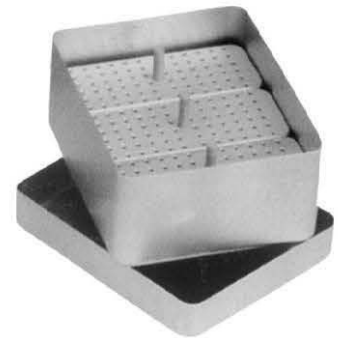
TM-164-2570 Lester Pumice Cup



TM-164-2571 Endo Box Round



TM-164-2572 Endo Box



TM-164-2573 Endo Box Trio



TM-164-2574 Cotton Holder with Lid



TM-164-2575 Cotton Holder without Lid



TM-164-2576 Cotton Holder Estrella without Lid

Registered Office:



GROWELL TRADING SAS

Av. El Dorado No. 68 C61
oficina 418 Bogota-Colombia

M: +57 324 2325592

E: info@gwelltrade.com

Web: www.gwelltrade.com

Registro Sanitario No:

INVIMA 2025DM-0031755

Cámara de Comercio No. 03905028

**Número de Identificación Tributaria
(NIT) 9019065632**



ISO 9001:2015

ISO 13485:2016